

JUNE, 1928

25 CENTS

RADIO

(REG. U. S. PATENT OFF.)



In This Issue ~

AN AUTOMATIC RADIO RECEIVER • By G. M. BEST

MAGNAVOX DYNAMIC POWER SPEAKERS

NOW

\$35

UP-FOR UNITS

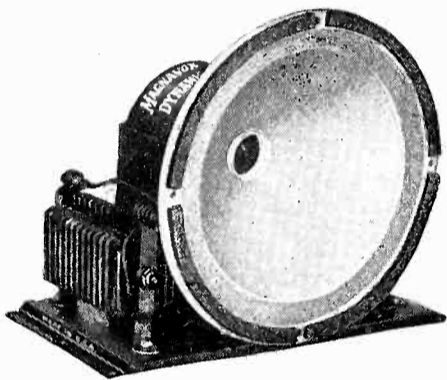

DYNAMIC 80

110 volts AC. Has power transformer and dry rectifier. The most popular unit of the new line. Designed to operate with AC. sets. *Unit, list \$50.*

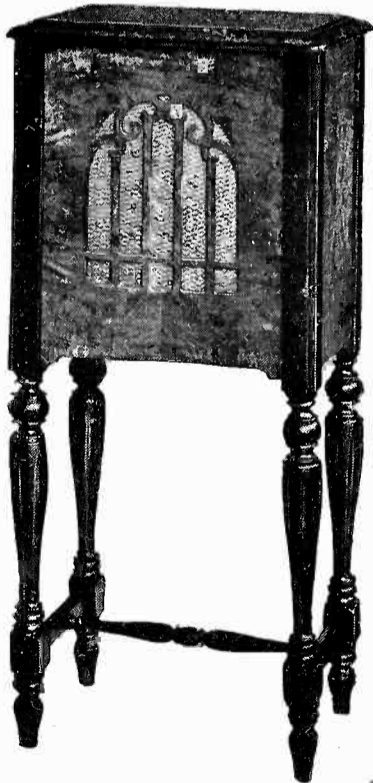

ARISTOCRAT MODEL

Beautiful butt burl walnut cabinet finished in two tones. It houses Dynamic 6, 7 or 80 unit. List prices:

*With Dynamic 6, \$70
Dynamic 7, \$75; Dynamic 80, \$85*

NEW improved models for both AC and DC operation. New low prices, \$35 up. Dynamic speakers now compete in price with ordinary types of speakers.

Magnavox Dynamic is the original radio loud speaker. Created by Magnavox 17 years ago. Patented and controlled exclusively by Magnavox. 400,000 in use and never has the popularity of the dynamic speaker been greater than right now. Adopted as built-in equipment during the past six months by several makers of fine sets.

Send for Dynamic Speaker bulletins giving full information.

THE MAGNAVOX CO.
Oakland, California

Eastern Sales Office:
1315 South Michigan Ave., Chicago

MAGNAVOX
DYNAMIC
Power Speakers

Protected under 13 patents. Infringements will be prosecuted.



**CORDOVA
MODEL**

With dynamic 700 unit, 110 volt, 60 cycle AC. Combining rectifier and power amplifier. Takes place of last audio stage in set. Operates with one 381 or 281 tube and one 310 or 210 tube. Handsome walnut cabinet. *List \$175. Unit \$125*

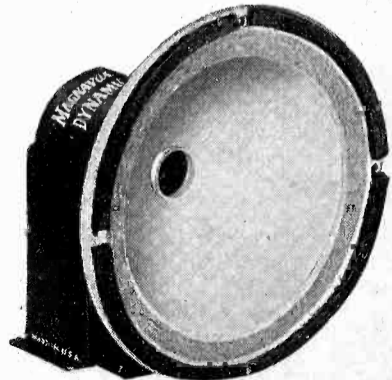

DYNAMIC 6

6 volts DC. Field current consumption, .65 amperes. Operates from A battery. *Unit list price \$35.*

DYNAMIC 7

110 to 220 volts DC. Field current consumption, 45 to 90 milliamperes. *Unit, list \$40.*



FADA
Radio

Leads

In Real Radio Achievement!

First in the Field

Fada is one of the oldest and largest exclusive radio manufacturers in the world. Fada was established in 1920, the same year as regular commercial broadcasting. Fada has never manufactured anything but radio receivers, parts and speakers and its success is due to devoting its entire energies to radio.

First in Neutrodyne

Fada was the first manufacturer to adopt the highly efficient neutrodyne principle, and combined with the tuned radio frequency principle, is used in the manufacture of Fada sets today.

First in 1926

In 1926 Fada introduced six and eight-tube shielded multi-stage receivers that showed such marked improvement

and mastery of design that public acceptance acclaimed them the standards of supremacy.

First in Dependable A. C. Sets

Fada was the first manufacturer to successfully design A. C. tube electric receivers using the 227 type RCA or Cunningham tubes in all radio and audio stages except the power amplifier. When used in a properly designed set these indirect heater element tubes are recognized by engineers as the most efficient for commercial radio use.

First in 1928

Fada will continue to be first in designing sets and speakers that give lasting radio satisfaction and real permanent results.

Stick to known quality for continued success as a radio merchant.

F. A. D. ANDREA, Inc.

Executive Offices and Factory

Jackson Ave., Orchard and Queens St.

Long Island City, N. Y.

Branches:

F. A. D. ANDREA, Inc.
2619 So. Michigan Ave.
CHICAGO, ILL.

FADA RADIO, Ltd.
821 Queens St., E.
TORONTO, CANADA

Agents and representatives in every civilized country in the world

Hear Harmonated Reception (the sweetest tone ever known) on a Fada Radio

Branches:

F. A. D. ANDREA, Inc.
5 Third Street
SAN FRANCISCO, CALIF.

FADA RADIO, Ltd.
LONDON, ENG.

Tell them you saw it in RADIO

RADIO

Established 1917

Published Monthly by the Pacific Radio Publishing Co.

ARTHUR H. HALLORAN,
Editor

H. W. DICKOW,
Business Manager

GERALD M. BEST,
Technical Editor

A. I. RIVETT,
Draughtsman

Entered as second-class matter at Post Office at
San Francisco, Calif.

Copyright 1928 by the Pacific Radio Publishing Co.

Address all communications to

PACIFIC RADIO PUBLISHING COMPANY
Pacific Building, San Francisco, California

Vol. X

JUNE, 1928

No. 6

CONTENTS

RADIOTORIAL COMMENT.....	9
TELEPHOTO TRANSMISSION OF MOTION PICTURES.....	10
<i>By Clinton Osborne</i>	
WEATHER SERVICE FOR AVIATORS.....	11
<i>By S. R. Winters</i>	
AN AUTOMATIC RADIO RECEIVER.....	12
<i>By G. M. Best</i>	
A HOME-MADE PHOTO- ELECTRIC CELL.....	15
<i>By John P. Arnold</i>	
VAGARIES OF THE ETHER.....	16
<i>By Wallace Kelk</i>	
AN EXPERIMENTAL SIX-TUBE SET.....	17
<i>By Francis Churchill</i>	
RESISTORS FOR VOLTAGE DIVIDERS.....	19
<i>By Howard Field, Jr.</i>	
SCIENTIFIC SET DESIGN.....	21
<i>By Richard F. Shea</i>	
HARMONIC CALIBRATION.....	23
<i>By E. A. Tubbs</i>	
ADDITIONAL DATA ON A. C. RECEIVERS.....	24
BAND PASS FILTERS.....	25
<i>By Arthur Hobart</i>	
QUERIES AND REPLIES.....	26
THE COMMERCIAL BRASSPOUNDER.....	27
FISHING TRAWLERS ON THE ATLANTIC COAST.....	27
<i>By G. W. Trudeau</i>	
"HAMANTICS".....	28
<i>By Paul Otto</i>	
JAPANESE CODES.....	28
<i>By Joseph N. Smith</i>	
WHY PRESENT RADIO CONDITIONS.....	29
<i>By L. W. Gillis</i>	
LETTERS TO THE EDITOR.....	29
AN AMATEUR TRANSMITTING ANTENNA FOR ALL BANDS.....	30
<i>By L. W. Van Slyck</i>	
A 50-WATT PORTABLE TRANSMITTER.....	31
<i>By D. B. McGown</i>	
RADIO KIT REVIEWS.....	32

FORECAST FOR JULY ISSUE

The chief feature of July RADIO is an illustrated description of next season's radio sets, parts and accessories as displayed at the R. M. A. show at Chicago in June. S. R. Winters describes some new and interesting aviation uses of radio. G. M. Best tells how to use a.c. tubes in the 115 K. C. superheterodyne and gives answers to a recent questionnaire on the qualifications for a radio engineer. C. Wm. Rados presents an interesting interview with Dr. A. E. Kennelly entitled "The Spider's Web." Arthur Hobart gives a short-cut method for figuring great circle distances. There is further discussion on radio-television, an article on "Volume Control Methods" by Nelson P. Case, and the usual departments.

Cunningham RADIO TUBES

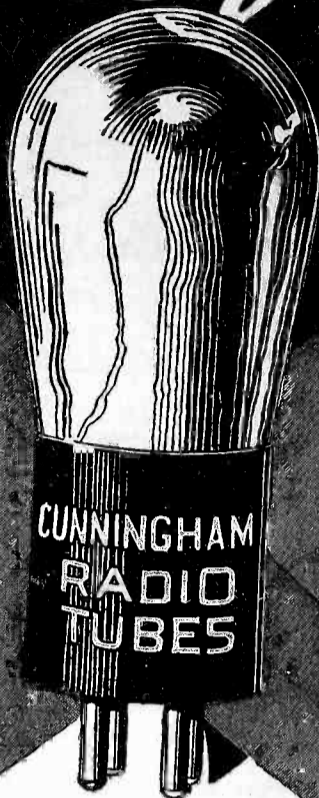

*Superior in Quality
Outstanding in
Performance*

*The Choice
of
Millions*

*You can depend
on their performance*

because Cunningham Radio Tubes
are guaranteed against electrical and
mechanical defects in construction.

*Look for the name Cunningham
on the Orange and Blue Carton.*

E. T. CUNNINGHAM, INC.

NEW YORK

CHICAGO

SAN FRANCISCO

Manufactured and sold under rights, patents and inventions owned and/or controlled by Radio Corporation of America

Since 1915 STANDARD for all sets

Use this Coupon and Save Money

The next six issues of "RADIO" will be outstanding editorially. Plans have been completed for again publishing the annual show number. The July issue of "RADIO" will give you the first information on the new radio models as exhibited at the Radio Manufacturer's Association show in Chicago. Copies of last year's special show issue sold fast. The demand exceeded the supply. We urge you to subscribe now—today—at the special rate of one dollar for six months in order to protect yourself against missing the next six issues of "RADIO." Attach a dollar bill, check or money order to this coupon and mail now.

Name.....

Street and No.....

City and State.....

Tell them you saw it in RADIO

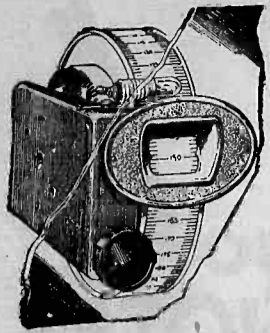

POPULAR CIRCUITS SPECIFY REMLER

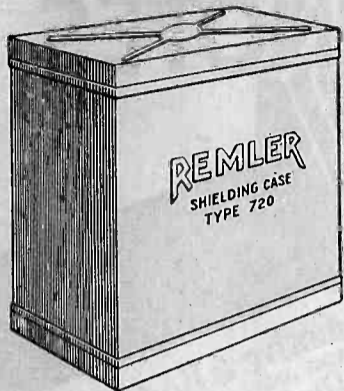
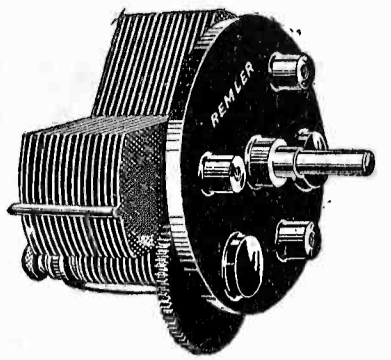

The Radio Engineer, when designing a circuit, takes no chances. He cannot afford to let doubtful or inferior parts wreck the performance of his circuit. Rugged reliability is what he wants and must have.

He can secure a substitute—at a lower price—for every Remler Part, but he can find no substitute for Remler Reliability.

Here is a list of the circuits which specify Remler Parts. It reads like a "Who's Who" of Radio.

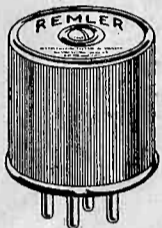
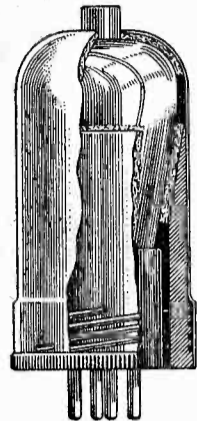

CIRCUITS SPECIFYING REMLER PARTS

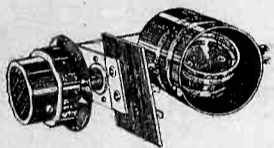

Nine-in-Line Super
Magnaformer 9-8
Best 45 K. C. Super
Infradyne
World's Record Super 10
Best Lincoln Radio
Madison-Moore A. C. One-Spot
Gerald M. Best 115 K. C. Super
La Peer A. R. 9
Unitone Symphonic
Bodine Twin Eight A. C.

Citizens 115 K. C. Super
St. James Twin Four
Remler 45 K. C. A. C. Super
Citizens Super Nine
The New Home Receiver
Braxton-King Stabilized Eight
The Unified Diamond
The A. C. 300 Receiver
Popular Mechanic's Super
The Quadrphase
World's Record Super 8

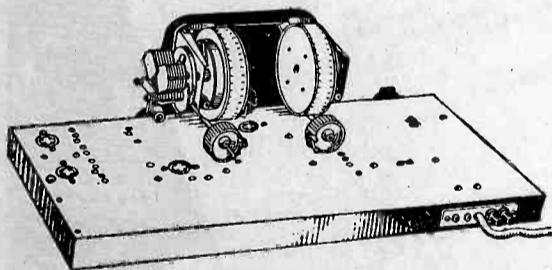
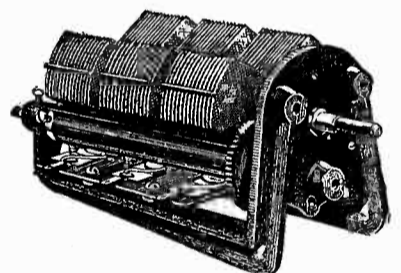
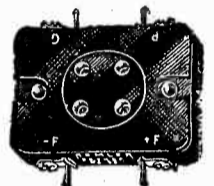

REMLER
GRAY and DANIELSON
Manufacturing Company

260 First Street, San Francisco

Chicago

New York

Eastern Warehouse, Elkhart, Indiana

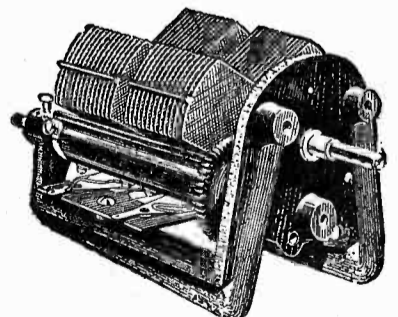
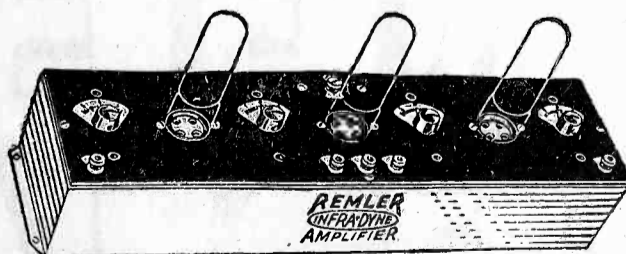
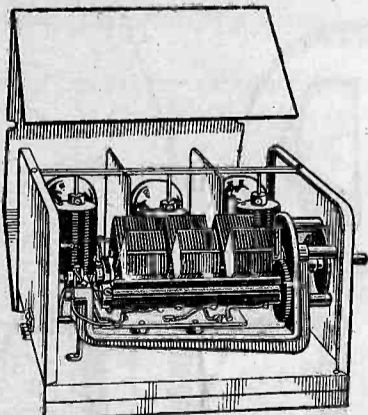
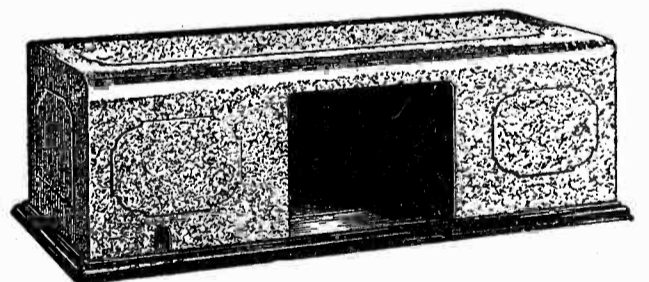

REMLER DIVISION, GRAY & DANIELSON MANUFACTURING CO. 260 First Street, San Francisco, Calif.

Please place my name on your mailing list to receive:

- Future literature.
- Bulletin Service for Professional Set-Builders.

Name..... Street..... City.....

Do you build and sell sets?.....

A NEW 26 INCH SPEAKER!

LOW NOTES LOW NOTES LOW NOTES

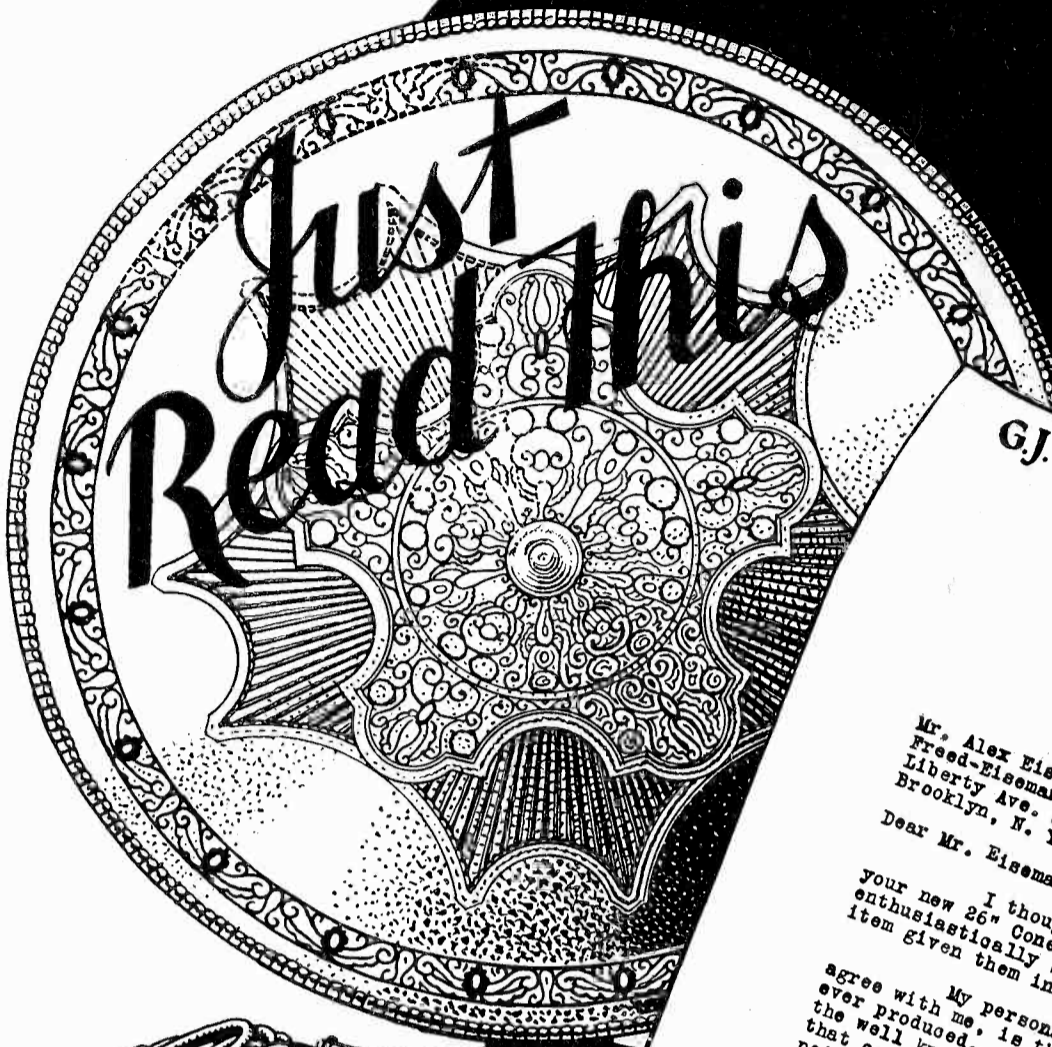

Model 330

Price \$35.
(Pacific Coast prices \$2. add'l)

G.J. Seedman Automotive & Radio Co., Inc.
JOBBER AND
Wholesale Distributors
BEDFORD AV East BROOKLYN
MADISON ST NEW YORK



March 16th, 1928.
PLEASE ADDRESS REPLY
ATTENTION OF
G. J. Seedman.

Mr. Alex Eisemann,
Freed-Eisemann Radio Corp.,
Liberty Ave. & Junius St.,
Brooklyn, N. Y.

Dear Mr. Eisemann:

I thought you would like to know that your new 26" Cone Speaker has been received more enthusiastically by our sales force than any new item given them in a long time.

My personal opinion, and all of the men agree with me, is that it is the finest Cone Speaker ever produced. We have made tests against all of the well known Cones and we have yet to find one that compares with the new Model 26 from the standpoint of natural reproduction and ability to take volume.

The enclosed order for three hundred additional Speakers which we require for immediate shipment is definite evidence of the fine acceptance it is enjoying at the hands of dealers.

I hope you are arranging to give the new Speaker wide publicity for you cannot exaggerate its quality, and anyone who buys the Speaker will feel indebted to you for the tip.

With best wishes for continued success and kindest regards, I am

Very truly yours

G.J. Seedman
President,
G.J. SEEDMAN COMPANY, INC.

GJS/MCT

FREED EISEMANN

FREED-EISEMANN RADIO CORP. BROOKLYN-NEW YORK

Tell them you saw it in RADIO



These quality instruments are Thordarson equipped:

WENETH
 SPARTON
 HOWARD
 FINECO
 Willard
 Pfanzagl
 GILFILLAN
 KENNEDY
 MAGNATON
 Neutrowound
 Prest-O-Lite
 Radiodyne
 Mohawk
 Buckingham
 MURDOCK
 WALBERT
 OZARKA
 ARGUS
 AUDIOLA
 ERLA
 and
 many others

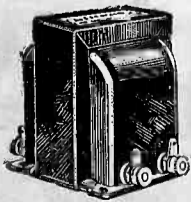

WHEREVER radio apparatus is demonstrated, note how the receivers equipped with Thordarson Transformers surpass in tonal reproduction.

This year, more than ever before, fidelity of reproduction is the determining feature in the sale of the better radio apparatus. Since the musical characteristics of a radio instrument depend to such a great extent on a wise selection of the audio and power supply transformers, it is significant that so many leading manufacturers have turned to Thordarson as the logical transformer source.

Equally significant is the fact that not once since Thordarson transformers became available to radio manufacturers has any other transformer approached the manufacturer popularity of Thordarson.

THORDARSON

RADIO TRANSFORMERS

Supreme in musical performance

Thordarson transformers are universally available to custom set builders as well as manufacturers. Wherever radio parts are sold, there you will find a complete stock of Thordarson Audio and Power Supply apparatus. If you are building for real musical performance, insist on Thordarson Transformers.

THORDARSON ELECTRIC MANUFACTURING CO.
Transformer Specialists Since 1895
WORLD'S OLDEST AND LARGEST EXCLUSIVE TRANSFORMER MAKERS
Huron and Kingsbury Streets — Chicago, Ill. U.S.A. 3581

Tell them you saw it in RADIO

RADIO

Established 1917

Published Monthly by the Pacific Radio Publishing Co.

ARTHUR H. HALLORAN,
Editor

H. W. DICKOW,
Business Manager

GERALD M. BEST,
Technical Editor

A. I. RIVETT,
Draughtsman

Entered as second-class matter at Post Office at
San Francisco, Calif.

Copyright 1928 by the Pacific Radio Publishing Co.

Address all communications to

PACIFIC RADIO PUBLISHING COMPANY
Pacific Building, San Francisco, California

Vol. X

JUNE, 1928

No. 6

CONTENTS

RADIOTORIAL COMMENT.....	9
TELEPHOTO TRANSMISSION OF MOTION PICTURES.....	10
<i>By Clinton Osborne</i>	
WEATHER SERVICE FOR AVIATORS.....	11
<i>By S. R. Winters</i>	
AN AUTOMATIC RADIO RECEIVER.....	12
<i>By G. M. Best</i>	
A HOME-MADE PHOTO- ELECTRIC CELL.....	15
<i>By John P. Arnold</i>	
VAGARIES OF THE ETHER.....	16
<i>By Wallace Kelk</i>	
AN EXPERIMENTAL SIX-TUBE SET.....	17
<i>By Francis Churchill</i>	
RESISTORS FOR VOLTAGE DIVIDERS.....	19
<i>By Howard Field, Jr.</i>	
SCIENTIFIC SET DESIGN.....	21
<i>By Richard F. Shea</i>	
HARMONIC CALIBRATION.....	23
<i>By E. A. Tubbs</i>	
ADDITIONAL DATA ON A. C. RECEIVERS.....	24
BAND PASS FILTERS.....	25
<i>By Arthur Hobart</i>	
QUERIES AND REPLIES.....	26
THE COMMERCIAL BRASSPOUNDER.....	27
FISHING TRAWLERS ON THE ATLANTIC COAST.....	27
<i>By G. W. Trudeau</i>	
"HAMANTICS".....	28
<i>By Paul Otto</i>	
JAPANESE CODES.....	28
<i>By Joseph N. Smith</i>	
WHY PRESENT RADIO CONDITIONS.....	29
<i>By L. W. Gillis</i>	
LETTERS TO THE EDITOR.....	29
AN AMATEUR TRANSMITTING ANTENNA FOR ALL BANDS.....	30
<i>By L. W. Van Slyck</i>	
A 50-WATT PORTABLE TRANSMITTER.....	31
<i>By D. B. McGown</i>	
RADIO KIT REVIEWS.....	32

FORECAST FOR JULY ISSUE

The chief feature of July RADIO is an illustrated description of next season's radio sets, parts and accessories as displayed at the R. M. A. show at Chicago in June. S. R. Winters describes some new and interesting aviation uses of radio. G. M. Best tells how to use a.c. tubes in the 115 K. C. superheterodyne and gives answers to a recent questionnaire on the qualifications for a radio engineer. C. Wm. Rados presents an interesting interview with Dr. A. E. Kennelly entitled "The Spider's Web." Arthur Hobart gives a short-cut method for figuring great circle distances. There is further discussion on radio-television, an article on "Volume Control Methods" by Nelson P. Case, and the usual departments.

Cunningham RADIO TUBES



Superior in Quality
Outstanding in
Performance

The Choice
of
Millions

You can depend
on their performance

because Cunningham Radio Tubes
are guaranteed against electrical and
mechanical defects in construction.

Look for the name Cunningham
on the Orange and Blue Carton.

E. T. CUNNINGHAM, INC.

NEW YORK

CHICAGO

SAN FRANCISCO

Manufactured and sold under rights, patents and inventions owned and/or controlled by Radio Corporation of America

Since 1915 STANDARD for all sets

Use this Coupon and Save Money

The next six issues of "RADIO" will be outstanding editorially. Plans have been completed for again publishing the annual show number. The July issue of "RADIO" will give you the first information on the new radio models as exhibited at the Radio Manufacturer's Association show in Chicago. Copies of last year's special show issue sold fast. The demand exceeded the supply. We urge you to subscribe now—today—at the special rate of one dollar for six months in order to protect yourself against missing the next six issues of "RADIO." Attach a dollar bill, check or money order to this coupon and mail now.

Name.....

Street and No.....

City and State.....

Tell them you saw it in RADIO

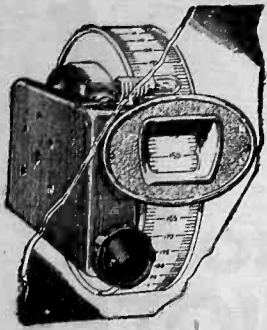

POPULAR CIRCUITS SPECIFY REMLER

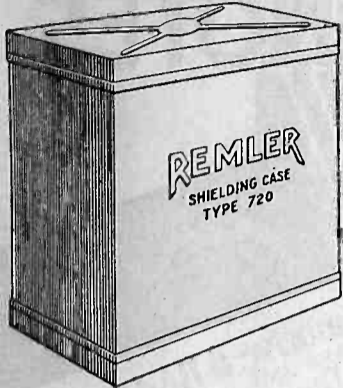
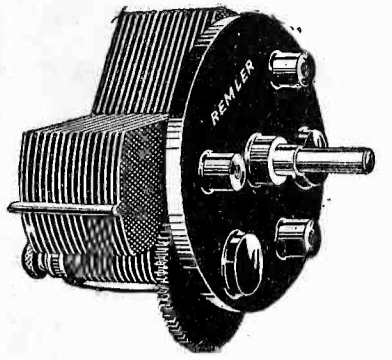

The Radio Engineer, when designing a circuit, takes no chances. He cannot afford to let doubtful or inferior parts wreck the performance of his circuit. Rugged reliability is what he wants and must have.

He can secure a substitute—at a lower price—for every Remler Part, but he can find no substitute for Remler Reliability.

Here is a list of the circuits which specify Remler Parts. It reads like a "Who's Who" of Radio.

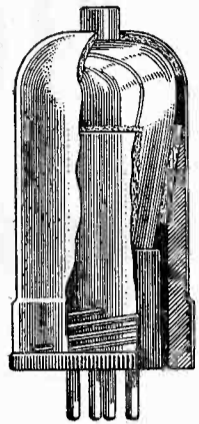

CIRCUITS SPECIFYING REMLER PARTS

Nine-in-Line Super
Magnaformer 9-8
Best 45 K. C. Super
Infradyne
World's Record Super 10
Best Lincoln Radio
Madison-Moore A. C. One-Spot
Gerald M. Best 115 K. C. Super
La Peer A. R. 9
Unitone Symphonic
Bodine Twin Eight A. C.

Citizens 115 K. C. Super
St. James Twin Four
Remler 45 K. C. A. C. Super
Citizens Super Nine
The New Home Receiver
Braxton-King Stabilized Eight
The Unified Diamond
The A. C. 300 Receiver
Popular Mechanic's Super
The Quadrphase
World's Record Super 8

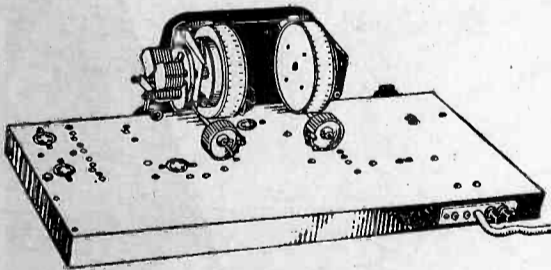
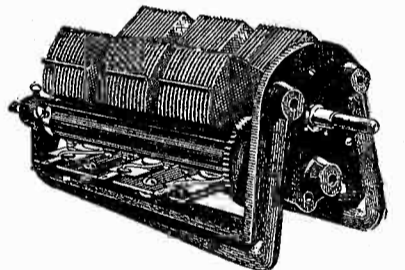
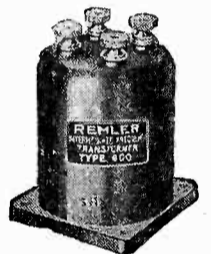
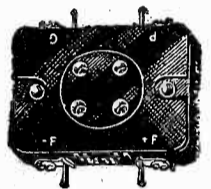
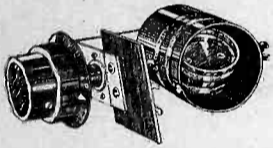

REMLER
GRAY and DANIELSON
Manufacturing Company

260 First Street, San Francisco

Chicago

New York

Eastern Warehouse, Elkhart, Indiana

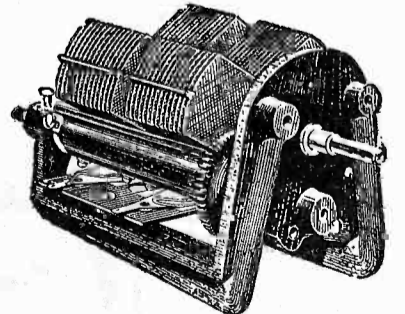
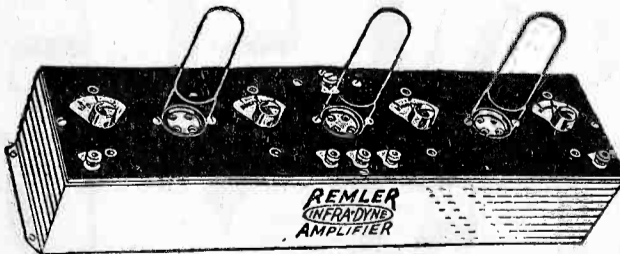
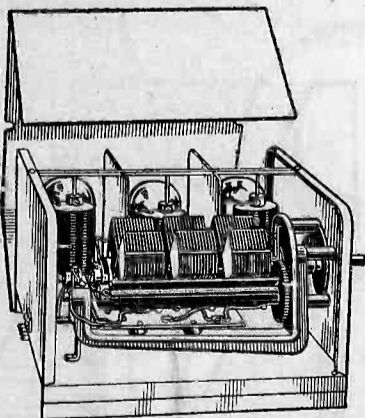
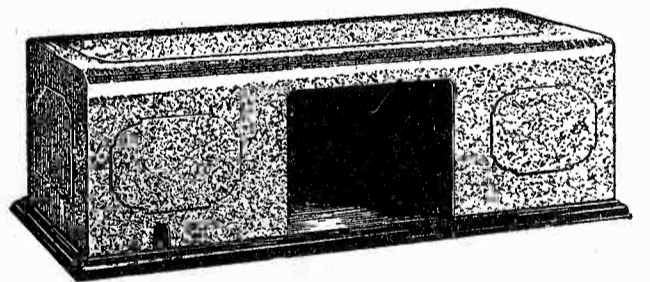

REMLER DIVISION, GRAY & DANIELSON MANUFACTURING CO. 260 First Street, San Francisco, Calif.

Please place my name on your mailing list to receive:

- Future literature.
- Bulletin Service for Professional Set-Builders.

Name..... Street..... City.....

Do you build and sell sets?.....

A NEW 26 INCH SPEAKER!

**LOW NOTES
LOW NOTES
LOW NOTES**

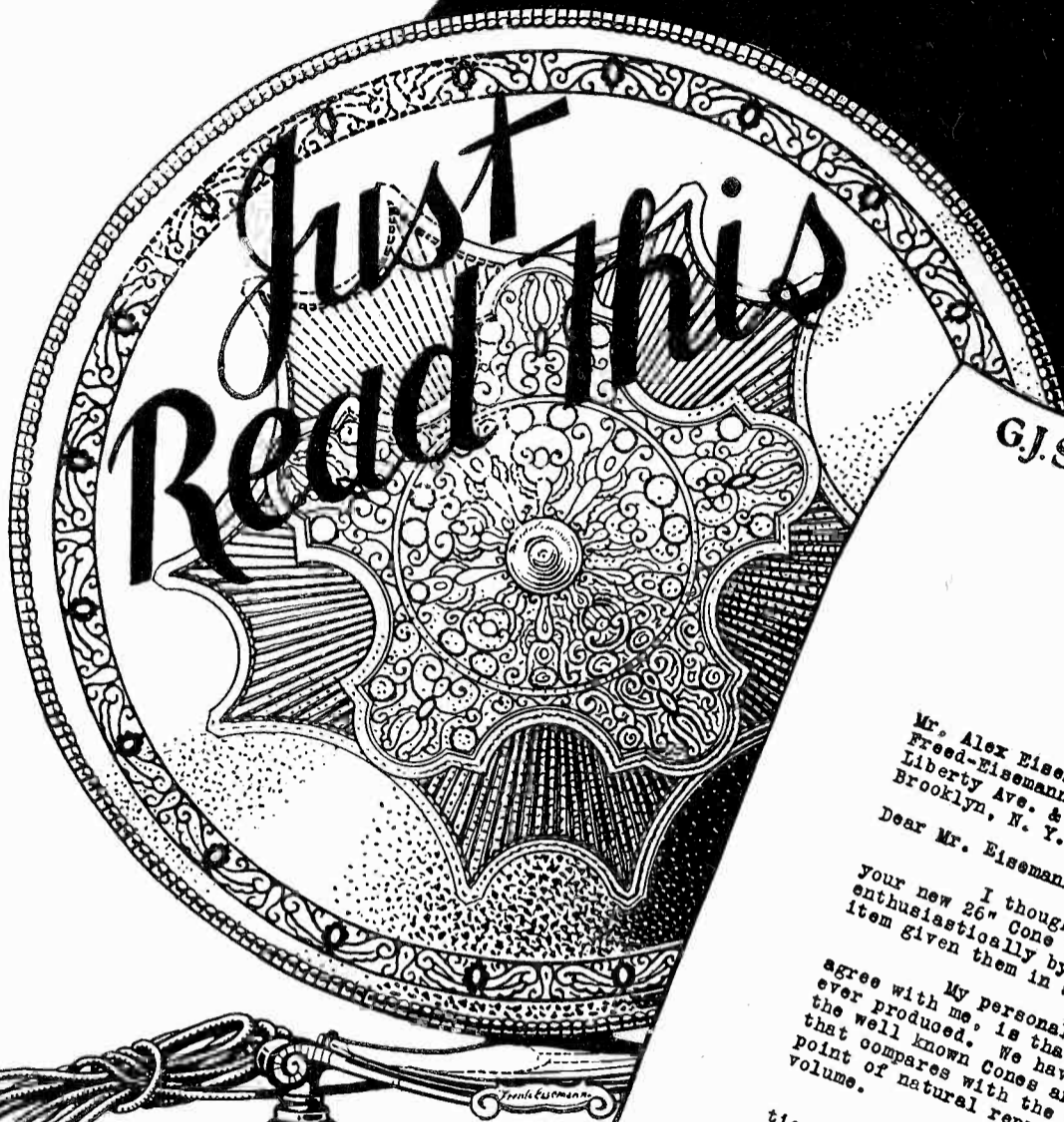

Model 330

Price \$ 35.
(Pacific Coast prices \$ 2. add'l)

G.J. Seedman Automotive & Radio Co., Inc.
JOBBER AND
Wholesale Distributors
BEDFORD AVE. at MADISON ST.
BROOKLYN NEW YORK



March 16th, 1928.
PLEASE ADDRESS REPLY
ATTENTION OF

G. J. Seedman.

Mr. Alex Eisemann,
Freed-Eisemann Radio Corp.,
Liberty Ave. & Junius St.,
Brooklyn, N. Y.

Dear Mr. Eisemann:

I thought you would like to know that your new 26" Cone Speaker has been received more enthusiastically by our sales force than any new item given them in a long time.

My personal opinion, and all of the men agree with me, is that it is the finest Cone Speaker ever produced. We have made tests against all of the well known Cones and we have yet to find one that compares with the new Model 26 from the standpoint of natural reproduction and ability to take volume.

The enclosed order for three hundred additional Speakers which we require for immediate shipment is definite evidence of the fine acceptance it is enjoying at the hands of dealers.

I hope you are arranging to give the new Speaker wide publicity for you cannot exaggerate its quality, and anyone who buys the Speaker will feel indebted to you for the tip.

With best wishes for continued success and kindest regards, I am

Very truly yours,

G.J. Seedman
President,
G.J. SEEDMAN COMPANY, INC.

GJS/MCT

FREED EISEMANN

FREED-EISEMANN RADIO CORP. BROOKLYN-NEW YORK

Tell them you saw it in RADIO

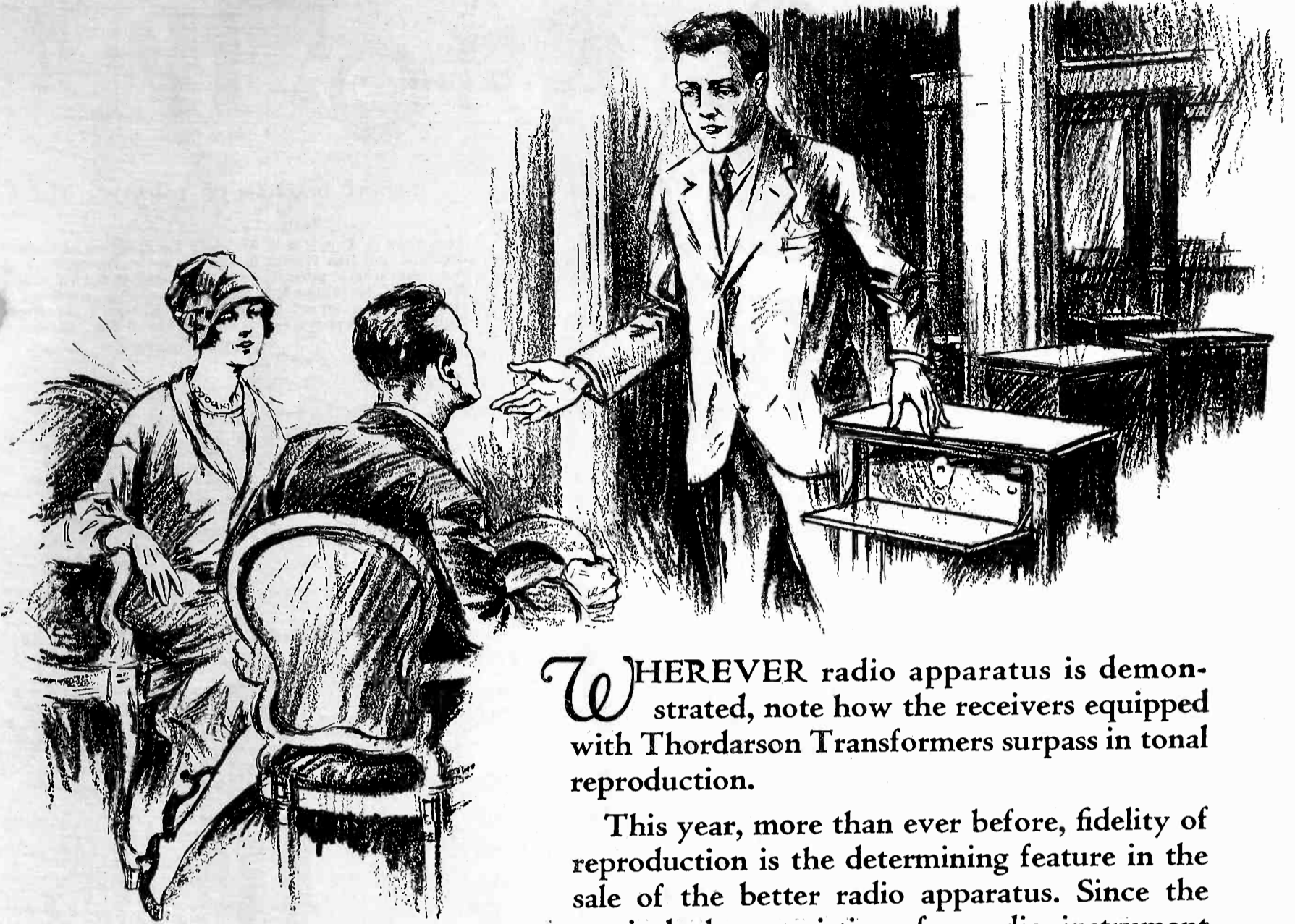

These quality instruments are Thordarson equipped:

WENITH
 SPARTON
 HOWARD
 PHIPPS
 Willard
 Pfamstahl
 GILFILLAN
 KENNEDY
 MAGNAVOX
 Neutrowound
 Prest-O-Lite
 Radiodyne
 Mohawk
 Buckingham
 MURDOCK
 WALBERT
 OZARKA
 ARGUS
 AUDIOLA
 ERLA
 and
 many others

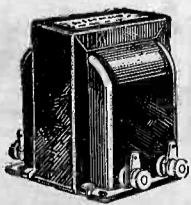

WHEREVER radio apparatus is demonstrated, note how the receivers equipped with Thordarson Transformers surpass in tonal reproduction.

This year, more than ever before, fidelity of reproduction is the determining feature in the sale of the better radio apparatus. Since the musical characteristics of a radio instrument depend to such a great extent on a wise selection of the audio and power supply transformers, it is significant that so many leading manufacturers have turned to Thordarson as the logical transformer source.

Equally significant is the fact that not once since Thordarson transformers became available to radio manufacturers has any other transformer approached the manufacturer popularity of Thordarson.

THORDARSON

RADIO TRANSFORMERS

Supreme in musical performance

Thordarson transformers are universally available to custom set builders as well as manufacturers. Wherever radio parts are sold, there you will find a complete stock of Thordarson Audio and Power Supply apparatus. If you are building for real musical performance, insist on Thordarson Transformers.

THORDARSON ELECTRIC MANUFACTURING CO.
Transformer Specialists Since 1895
WORLD'S OLDEST AND LARGEST EXCLUSIVE TRANSFORMER MAKERS
Huron and Kingsbury Streets — Chicago, Ill. U.S.A. 3581



Master Your Volume

Whatever set you own or are building, perfect control of volume, from a whisper to the intensity of a brass band, is at your finger tips with ELECTRAD TONATROLS.

PERFECT control of volume to adapt your reception to the occasion and individual taste, is necessary for the full enjoyment of your radio. As circuits vary widely, so must the recommended systems of controlling volume.

In Electrad *Tonatrols*, we offer the perfected and efficient means of volume and sensitivity control. And because of the necessity of specialized volume control in A.C. circuits, we have designed types of Tonatrols to meet the exacting A.C. requirements.

Tonatrols are variable resistors of the famous Royalty type. They are made plain, or with battery switch or power switch attached. If the proper Tonatrol for your receiver is not given here, our engineering department will be glad to help you select the proper design.

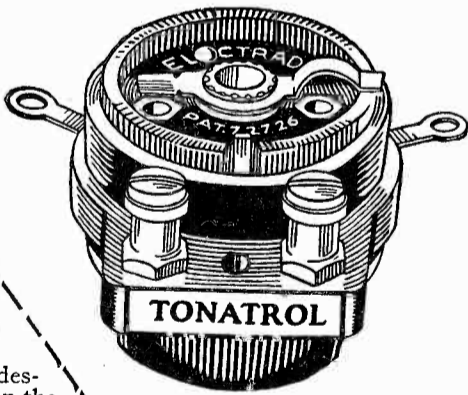

Tonatrol Standard Types P., R., and S., \$1.50; with battery switch, \$2.00; with power switch, \$2.50. Tonatrol Type A, \$2.00; with battery switch, \$2.50; with power switch, \$3.00.

Tear out and mail coupon for complete FREE Circulars and full information.

ELECTRAD, INC.,
Dept. 16-H,
175 Varick Street,
New York.

Please send me descriptive circulars on the following products and put me on your mailing list for similar literature.

- General Circular
- Tonatrol Volume Controls
- Phasatrols
- Royalty Variable Resistors
- "Electrad Control Manual" (Enclose 10c for mailing.)
- "What B Eliminator Shall I Build?" (Enclose 10c for mailing.)

I am particularly interested in.....

Name.....

Address.....

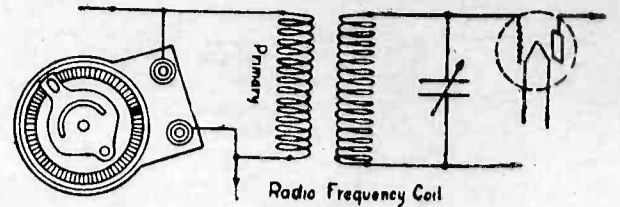

Fig. 1

CIRCUIT DIAGRAM OF TONATROL Type P

TONATROL TYPE P

This type of Tonatrol is designed for receivers of uncertain stability, yet less violent in their tendency to oscillate than the conventional potentiometer stabilized tuned r.f. circuits. Especially recommended for the following receivers and closely similar types; Grebe MU-1; Kolster 6 D; Bremer-Tulley Counterphase 6-37; Fada 8-480 B.S.F. 50/80.

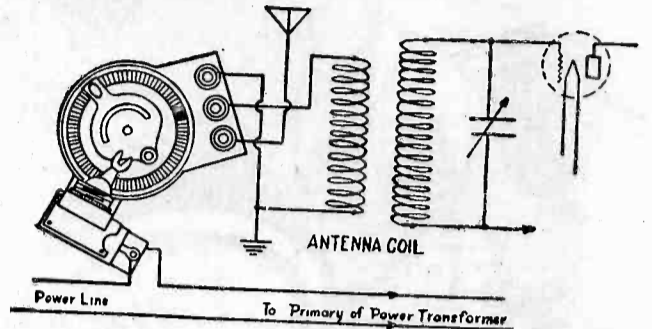

Fig. 3

CIRCUIT DIAGRAM OF TONATROL Type AP

TONATROL TYPE A

Antenna Type for Non-oscillating Receivers The above circuit indicates the most simple method of controlling volume. Tonatrol Type A.P. is wired to the antenna and receiver by three simple connections. Adapted only for relatively staple circuits such as Fada 7-475 A.S.F. 45/75; Grebe 7; The Bosch Cruiser; Crosley Bandbox; Stromberg Carlson 501A; Thermodyne T.F. 5; Zenith 11 or 14.

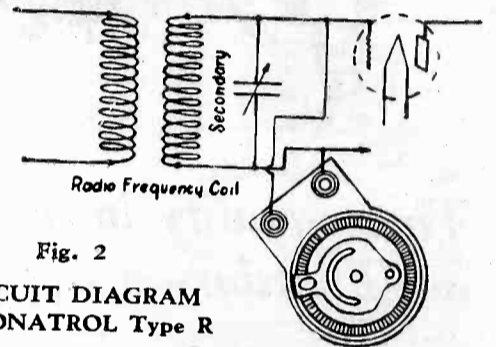

Fig. 2

CIRCUIT DIAGRAM OF TONATROL Type R

TONATROL TYPE R

Tonatrol Type R is designed for connection across the secondary of a radio frequency amplifying transformer as shown in accompanying diagram. Recommended for such receivers as Atwater-Kent; Freshman Masterpiece; home-built tuned r.f. sets; the Paragon models; Bosch models 66 and 76; and Bremer-Tulley Counterphase.

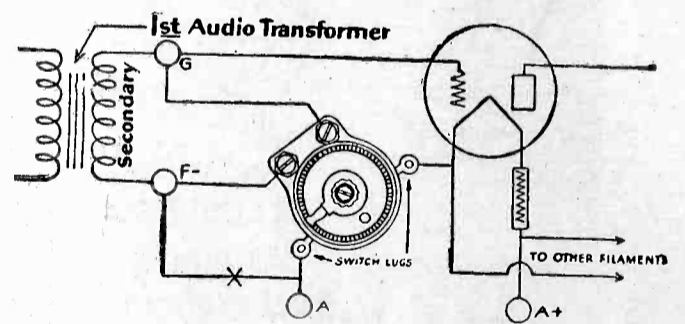

Fig. 4

CIRCUIT DIAGRAM OF TONATROL Type WS

TONATROL TYPE S

Audio Control for Non-oscillating Receivers Type S Tonatrol is designed for connection across the secondary transformer of the first audio frequency amplifying transformer. This type is usually used as an auxiliary volume control in addition to an oscillation or regeneration control. Used as suggested it will generally improve tone quality.

ELECTRAD

Incorporated

Pacific Coast Office: 905 Mission Street, San Francisco, California

Tell them you saw it in RADIO

RADIO

VOLUME X

JUNE, 1928

No. 6

Radiatorial Comment

Undue publicity is being given to the early advent of radio television in the home. It is being announced as "just around the corner." Television attachments for present radios are to be sold for \$32.50. The full action of a football game may be seen instantaneously in any home during the next season. And so on, *ad nauseam* and *ad bunkum*.

Likewise hundreds of religious enthusiasts, from time to time in the past, have been led to the belief that the world was coming to an end on a specified day. In anticipation of the event they disposed of all worldly possessions. And how foolish they felt when the catastrophe failed to materialize as advertised!

Anyone who believes all the blurbs about radio television must be equally credulous. While this marvelous accomplishment is today crudely possible on a small scale and while scientists are strenuously working to refine it, the actual results are less satisfactory than were the first transoceanic radio telephone demonstrations in 1915. It required twelve years of intensive and expensive research to establish commercial transatlantic telephone service. With the tremendously greater problems yet to be solved in radio vision, is it not reasonable to assume that some little time must yet elapse before the present shadowographs can be perfected into commercial motion pictures?

Such great developments follow a course of gradual evolution. First there came the wire transmission of still pictures, which is now in regular commercial use. But this is as yet a slow process requiring about four hours for the transmission of enough film to make a one-minute showing on the motion picture screen.

Then there came the radio transmission of still pictures which, for limited applications, has also reached the commercial stage. Indeed, this will be in wide use during 1929 and a number of practical outfits for home reception of photographs will be available. Remarkable experiments are being made in the short-wave transmission of pictures, preceding the installation of commercial stations throughout the country. Fading has been obviated by the erection of three receiving aerials, so spaced that when fading occurs at one point there is none at the others. Thus, through connection to a central receiving station, there is no interruption to the continued reception of strong impulses. But it must be remembered that these are not motion pictures.

Then there came the marvelous demonstration of wire and radio transmission of television by the Bell Laboratories. But these were of an experimental nature and exceedingly expensive. A single receiving set would cost \$50,000 or more, which is hardly practical for general installation in homes. The transmitted images were scarcely recognizable and

would never pass muster with a movie fan. But the demonstrations, like the early experiments with radio telephony, proved that the feat could be done and verified the predictions of its ultimate practical accomplishment.

Since then many experimenters have been trying to solve some of the difficulties. One of the greatest of these, with present methods, is the requirement of a 40-kilocycle band for the transmitter and the necessity that all these frequencies be given equal amplification to avoid distortion in the receiver. As such a wide band is more available along a wire than through space, it is probable that wire transmission of television will precede radio transmission.

Other problems, such as those of synchronization and the production of great light intensities, while difficult, are not insurmountable. It is probable that the flexibility of the cathode-ray oscillograph can be adapted to solve some of these difficulties. Other means will be devised to solve others.

Radio vision today is a scientific curiosity. After some years of research and development it will become a practical reality, not as a cheap attachment to a present day radio receiver, but as a relatively expensive piece of apparatus. Any tales to the contrary should be liberally salted before being swallowed.

* * *

Vacuum tubes and their applications to radio have done more to develop the amateur experimenter than any other single factor in modern life. Amateur photography followed well-traveled high-ways in comparison with the pathless wilderness explored by pioneers in the field of the vacuum tube.

Yet today there are certain well-defined trails to guide those who would discover new ways of using this wonder-working bottle. And there are also certain blind alleys into which it is fruitless to stray. The best trails have been plainly blazed by the pioneers and many costly mistakes may be avoided by following their guidance.

Nevertheless, some constructors seem to think that they know more than the experienced designers of circuits which employ such tubes as the shielded-grid and a.c. types. When their own "improvements" fail they are prone to blame the circuit, which they have not followed, rather than their own departures therefrom. Fully half the questions which a troubleman is expected to answer arise from neglect to follow accepted practice.

While there is here no intention to discourage innovations, for they are the stuff from which progress is made, let the innovator be prepared to assume the responsibility for the changes that he makes. And let him also be ready to try the recommended practice when his changes are unsatisfactory, withholding his condemnation of a circuit until he has followed it implicitly.

Telephoto Transmission of Motion Pictures

By CLINTON OSBORNE

PUBLIC interest in telephone transmission of photographs was aroused recently by an announcement by the Bell System that motion pictures had been successfully transmitted between Chicago and New York over the long distance telephone wires. This news is of interest to radio experimenters in the telephotograph field, especially in view of the tremendous increase in the past year of the amateur motion picture fad, so that we can foresee the day not far distant when experimenters will be receiving sections of amateur motion picture scenes by radio, thus opening up another field into which radio and photography are interallied.

Ten feet of motion picture film showing in closeup the face of a famous screen

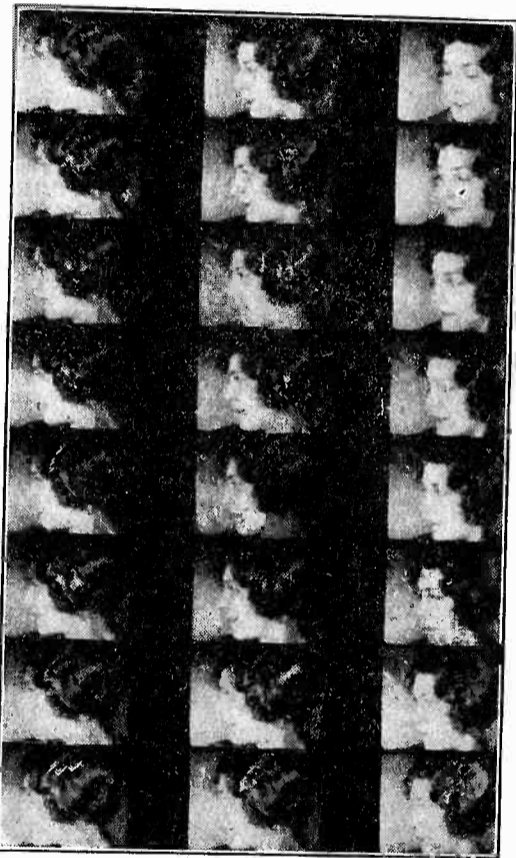

Fig. 1. Section of Motion Picture Film Transmitted by Wire

star, as shown in Fig. 1, was transmitted 1000 miles over the telephone wires, and in less than five hours after the sending of the film was begun, an accurate duplicate of the original film was being shown in a theater in New York City. The negative film was taken in Chicago at 10:30 a. m., as the screen star, Miss Vilma Banky, arrived by train from New York, and a few minutes later it was developed, dried and cut into strips six inches long. It was then placed, three strips at a time, between glass plates. These plates were rephotographed and a solid 5x7 inch positive film, like Fig. 1, was placed in the sending machine at Chicago.

This machine is shown in Fig. 2, which pictures a complete outfit now in

commercial every-day use in the transmission of still pictures between the various cities of the United States where permanent equipment is installed. Both sending and receiving machines have somewhat the same appearance as an Edison phonograph of the old cylindrical style. From an aperture on one side

the light and dark shades of the film cross the path of the beam. This current set up in the photo-electric cell was then amplified, and transmitted to New York over the telephone wires in much the same manner as an ordinary telephone conversation, and at the New York end, the electrical currents were

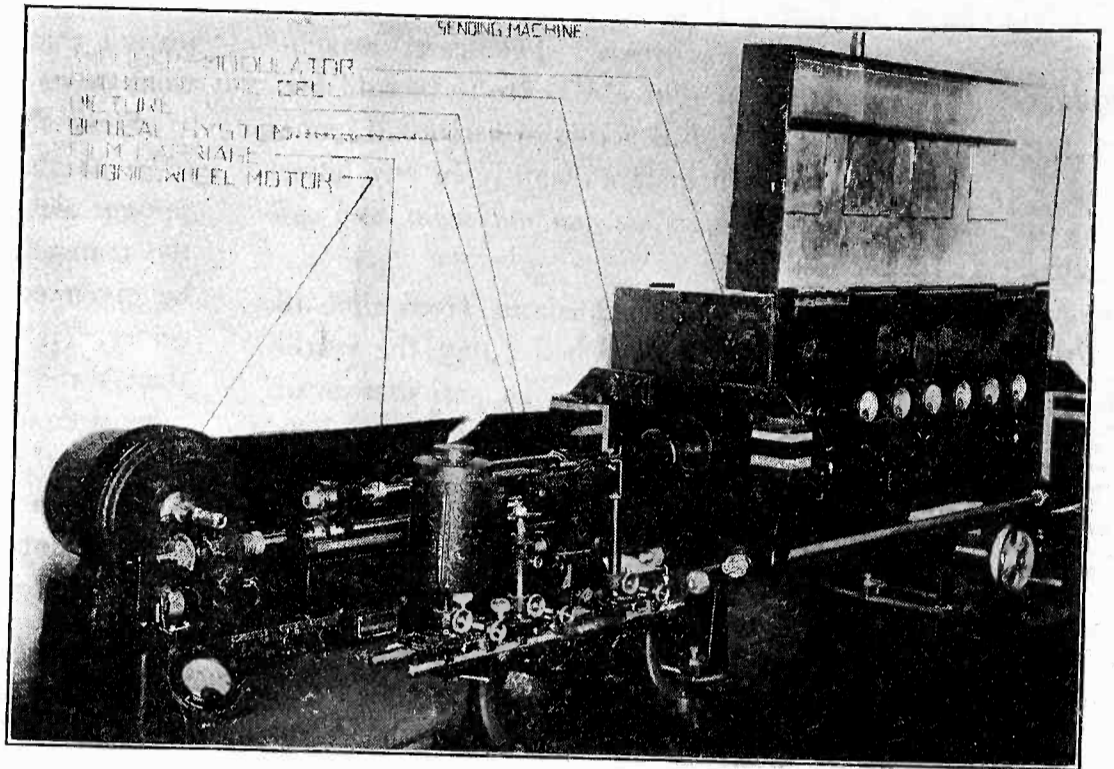

Fig. 2. Equipment at Sending End of Motion Picture Transmission

comes a bright penetrating beam of light, and this moves across the cylinder on which is curved the film which is to be transmitted. Each 5x7 film takes seven minutes to transmit, and all strips were numbered so that the continuity of the motion picture was not broken.

The electrical current is produced by the beam of light passing through the film and affecting a photo-electric cell, the intensity of the light being varied as the film is revolved on the drum, and

converted back to a beam of light by a system of amplifiers and a light valve, the equipment of which is shown in Fig. 3. The motors operating the sending and receiving equipments between two cities are driven by tuning forks which, combined with other apparatus, have the difficult assignment of keeping the motion of the films perfectly synchronized.

Due to the success of the first experiments, motion picture news-reel com-

(Continued on Page 36)

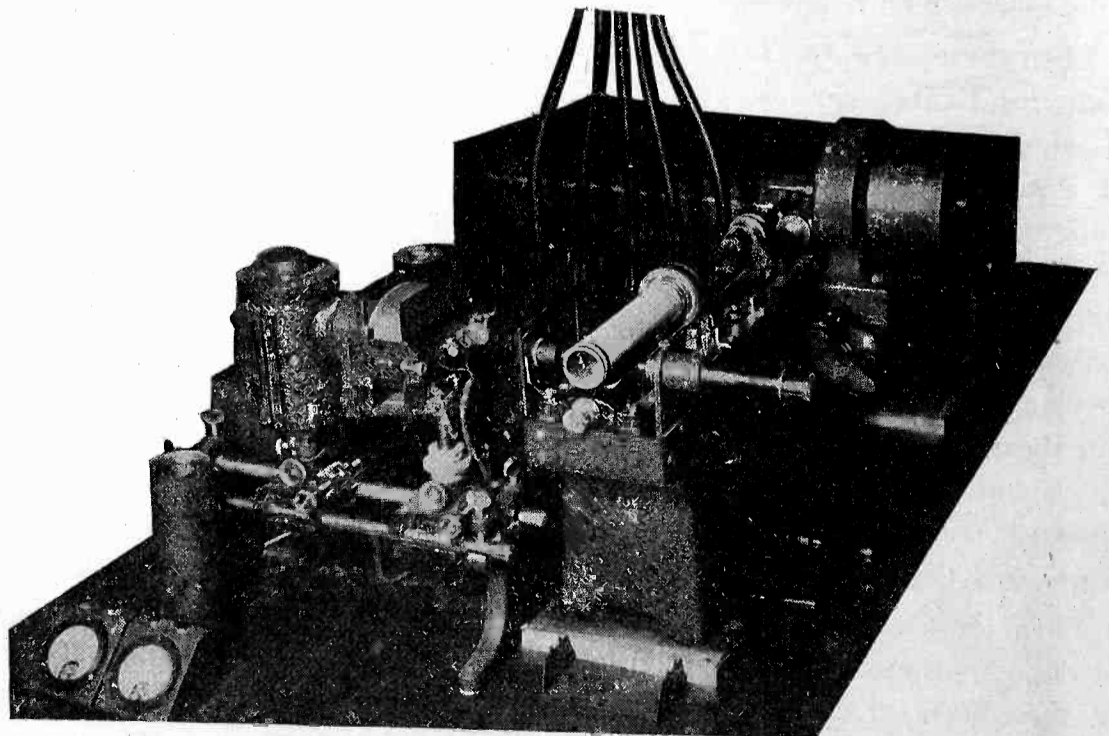

Fig. 3. Receiving Equipment of Commercial Telephoto Installation

Weather Service for Aviators

By S. R. WINTERS

THE \$2,705,000 appropriation for the Weather Bureau of the United States Department of Agriculture contains a fund of \$15,320 for a special meteorological service by radio for the benefit of aviators. This increase in the budget is in recognition of the plans of the Weather Bureau to continue its aviation forecast service from its central office in Washington and branch office in San Francisco.

This new radio service to aviators begins at 8:15 a. m.—one-half hour after the weather-observing stations file their observations, and one hour in advance of the regular weather-report releases. This enables aviators to start their cross-country flights and training with complete weather information early in the day, aiding them in the selection of routes that avoid adverse weather conditions. Previous to the establishment of a special meteorological service by radio, in Washington, six months ago, officials in charge of government aviation units complained that weather reports broadcast at 10:30 a. m. did not contain sufficient information for the planning of flights.

Furthermore, it was contended that the weather information was received so late in the day that aviators were already on their air journeys, having departed with a lack of adequate data on atmospheric conditions. Consequently, forced landings were frequent and often courses of flight had to be changed to steer clear of unpredicted storms. The establishment of a special meteorological service by radio served to correct this undesirable condition for aviators over the greater part of the United States. Military and civilian fliers in the far

West alone were deprived of this new radio service; hence, the appropriation for equipping a similar office in San Francisco.

The new system of broadcasting weather information will make it possible for aerological stations of the Navy Department and other government aviation units, from the Atlantic to the Pacific oceans, to plan their daily schedules at least two hours earlier than heretofore. This early getaway, however, is effected without sacrificing any of the needed meteorological data, since this special radio service has the full benefit of the regular Weather Bureau reports. The latter cover meteorological conditions throughout the United States, the Hawaiian Islands, parts of Canada and the West Indies. Through this new service the daily weather maps can be completed by aerologists at aviation fields by 9:30 a. m.

The specially outfitted aviation-weather-forecasting room in Washington contains automatic radio apparatus. The equipment, similar in operating principle to the telegraph printer, is connected by land line to a radio transmitter at Arlington, Virginia. This broadcasting set is actuated, by remote control, by this tape-perforating machine as it ticks away in the small room at the Weather Bureau. In addition to the automatic apparatus for remotely controlling the transmitter at Arlington, the equipment consists of a short-wave radio receiving set, provided with interchangeable tuning coils for varying the wavelengths over a wide band of frequencies. This receiver is used by the operator at the Weather Bureau in checking the accuracy of the forecasts as

they are dispersed by the naval radio station. The outfit to be installed at San Francisco will duplicate this setup.

Transmission is by use of the Weather Bureau word code, and the information will be broadcast on three wavelengths, 24.89, 37.34 and 75 meters, respectively. Eleven naval radio stations, equipped with short-wave receivers, have indicated their reception of these meteorological reports. These stations are located at: Lakehurst, N. J.; Boston, Mass.; Hampton Roads, Va.; Charleston, S. C.; Key West, Fla.; New Orleans, La.; San Juan, Porto Rico; Guantanamo Bay, Cuba; Brownsville, Texas; Great Lakes, Ill.; and San Diego, Calif.

While primarily designed to promote aviation, this forecasting service has great potential value to Wall Street, boards of trade, cotton exchanges, and other business interests. Commercial concerns and individuals equipped with short-wave receiving sets will be enabled to outwit legitimately a time-honored ruling of the Weather Bureau, namely, that weather forecasts must be released simultaneously throughout the country at 10:30 a. m. This new service, however, broadcasts weather information pertinent to crop production and prices at least an hour in advance of the regular forecasting service, which is released from the hundreds of local weather-observing stations at 10:30 a. m.

"This same service," points out E. B. Calvert, Chief of the Forecast Division of the Weather Bureau, "can be made applicable to transoceanic flying as soon as commercial aviation across the Atlantic Ocean becomes a regular and established means of transportation. This weather service, without which the hazards of transoceanic flights would be enormously increased, will be made possible by some permanent and dependable ocean-weather reporting arrangement, it is anticipated.

"In recent transatlantic flights this weather service was made possible largely by the voluntary cooperation of shipmasters and of the radio companies, which collected ocean weather information twice daily and delivered it to the Weather Bureau for charting and analyzing. In future transatlantic flying such voluntary cooperation will hardly be as readily forthcoming, since the novelty of the enterprise will be gone and public interest in it less keen.

"Officials of the Weather Bureau are, accordingly, figuring out what can be done to stimulate interest in ocean weather reports, which are valuable in forecasting weather conditions on land as well as in adding to the safety of flying and of navigation.

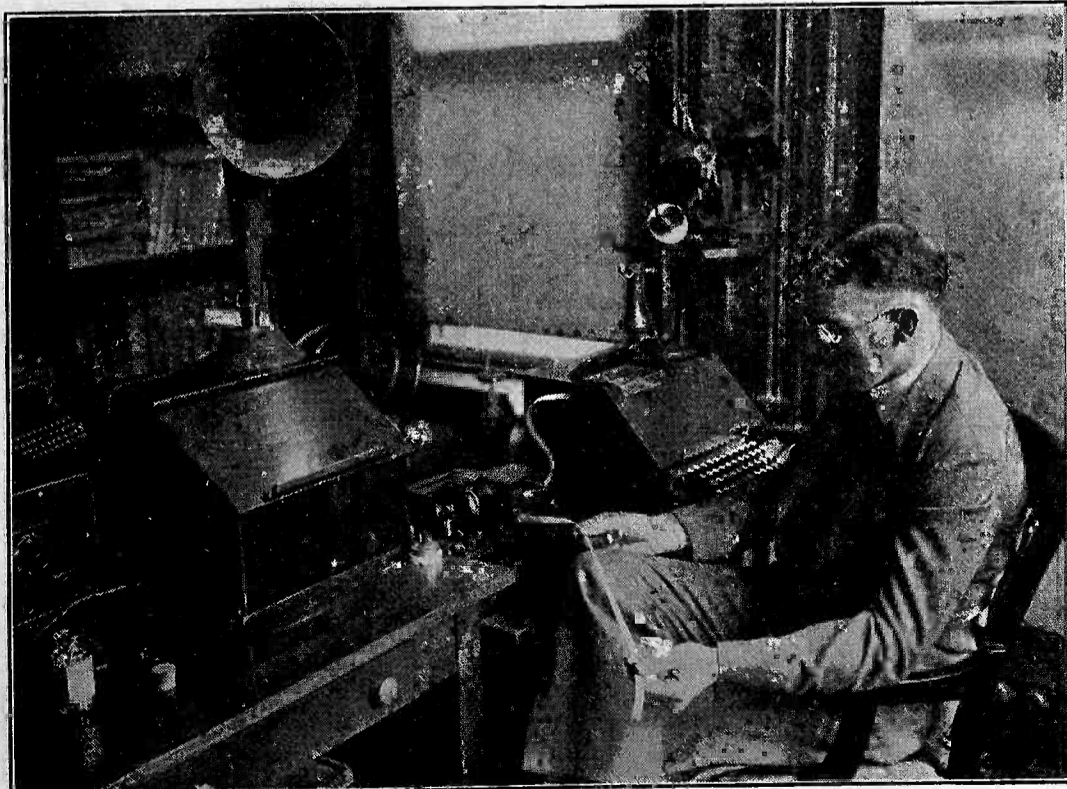

Automatic Code Transmitter for Broadcasting Information from Weather Bureau

An Automatic Radio Receiver

Directions for the Design and Construction of Push-Button Control of Local or Remote Receivers

By G. M. BEST

THE design of push-button control for any type of radio receiver is such a simple and oft-done task that recent mysterious announcements of automatic radio sets have greatly amused engineers who are familiar with the complex control circuits used in wire telephony. Any experimenter can easily apply multi-contact switches and relays so as to automatically operate condensers for tuning control.

The easiest method of automatically controlling a factory built receiver would be to provide a system of push-buttons which would advance the gang condenser in the r.f. amplifier by certain definite amounts according to pre-determined mechanical adjustments. Undoubtedly this method will have commercial application in a very short time. However, this method is not an easy one for the experimenter with limited machine shop facilities, and so two more practical ideas for automatic control are discussed here.

The most satisfactory type employs condensers adjusted to a specific frequency, so that a station operating on that frequency may be tuned in by turning one of a group of switches, each

labeled with the frequency or call letters of a station. A simple arrangement consists of two or more r.f. transformers with untuned primaries and with secondaries designed for tuning the broadcast band with condensers having a maximum capacity of not over .0005 mfd., a set of variable condensers of either the mica or air dielectric type, and a set of switches to cut the condensers in and out of the circuit.

A conventional circuit showing the necessary connections for a push-button type receiver for three stations is shown in Fig. 1. To increase the number of stations to be received, merely increase the number of switches and tuning condensers. For all practical purposes, the use of this receiver is confined to metropolitan areas, where there are several high grade broadcasting stations. If the set is to be located at some distance from broadcasting centers, where good reception requires careful tuning, a set with adjustable dials would be preferable. The circuit has one stage of tuned r.f., detector and two stages of audio.

The antenna coil is tuned with a .0005 mfd. condenser when used in the normal set-up of this receiver, and the

r.f. transformer secondary requires a .00025 mfd. variable. To automatically control these tuned circuits, merely provide a separate tuning condenser for each r.f. transformer, for each station which is to be received, so that in Fig. 1, a total of 6 tuning condensers will be required.

The use of variable air condensers gives a bulky and expensive layout. So condensers of the variable mica type such as the XL Variodenser are recommended. These condensers can be had in ranges from 20 mmf. to 1000 mmf. maximum, and are adjusted by means of a small set-screw on top of the condenser case. They take up small space, enough to provide 6 channels taking up less space than a pair of variable air condensers.

For the single r.f. stage circuit shown in Fig. 1, a double pole, double throw jack switch will be needed for each pair of tuning condensers, which are connected to the switch in the manner shown. If there are more than two tuned circuits, additional pairs of contacts will be needed for each extra tuned circuit, although with a receiver having two or more stages of tuned r.f., it would be necessary to take special pre-

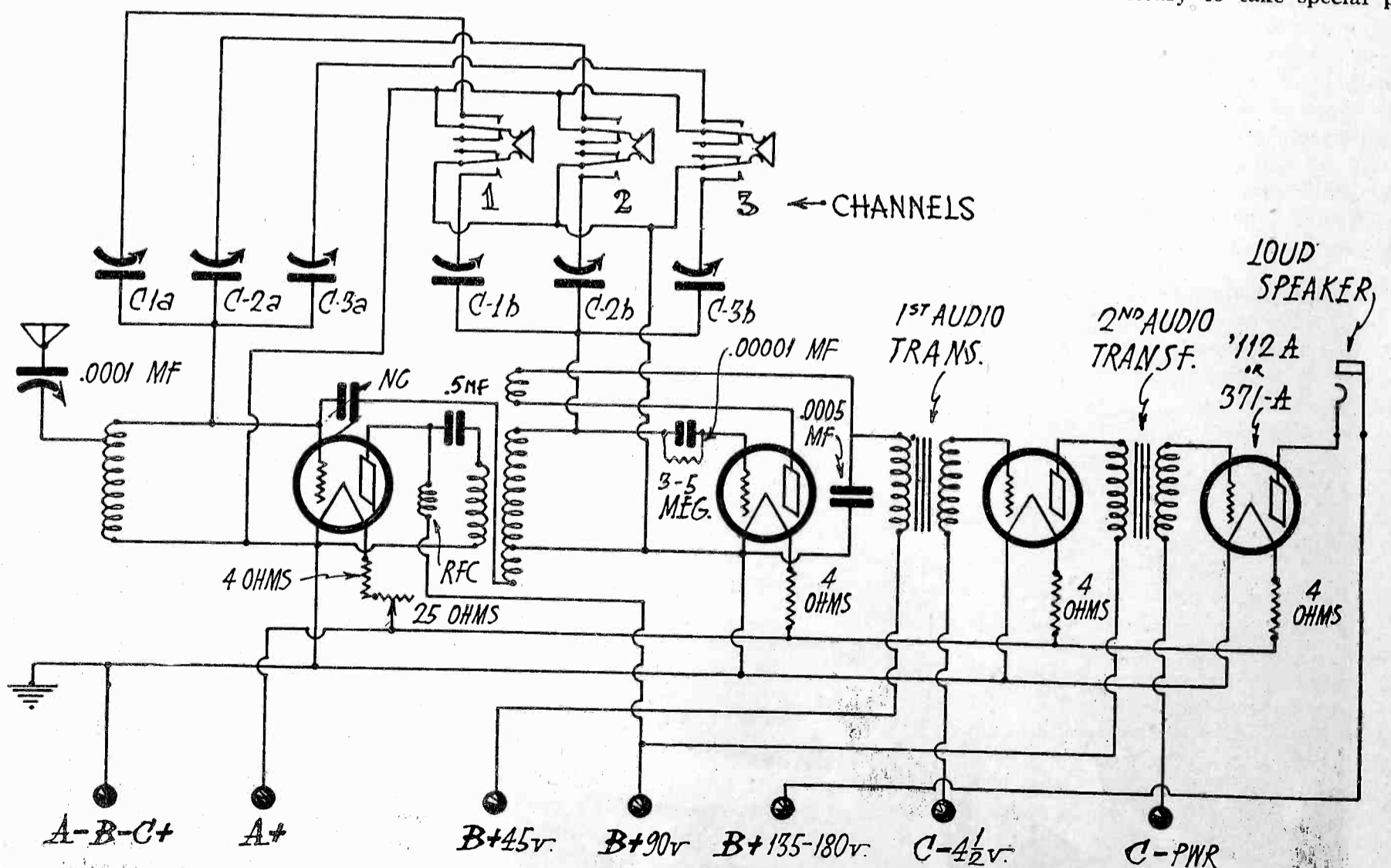

Fig. 1. Circuit for Three-Channel Automatic Radio Receiver

cautions to avoid oscillation due to the proximity of the tuning connections to the grid circuits of the various tubes.

The receiving set is that described in January RADIO by Glenn S. Browning, except that the variable tuning controls have been omitted. The space occupied by the drum dial and variable condensers can be occupied by the switches and groups of tuning condensers, so that no extra panel space will be required.

In Fig. 1, condensers C_{1a} and C_{1b} tune the antenna coil and r.f. transformer respectively, when the switch associated with Channel 1 is operated, to the frequency selected for that channel. Likewise condensers C_{2a} and C_{2b} tune the 2nd channel, and C_{3a} and C_{3b} tune the 3rd channel. To adjust the tuning condensers, the switch is set first for Channel 1, and by the use of a screw-driver having an insulated handle, condenser C_{1a} is adjusted so that the capacity is about half the maximum amount, and then C_{1b} is turned until the station selected for Channel 1 is heard. The two condensers are then adjusted until the station is heard with maximum volume, and the adjustment can then be repeated for Channels 2 and 3.

The regeneration control can be omitted if regeneration is not needed, but must be used if some of the stations selected are too distant to be received with loud speaker volume otherwise. The main volume control is a 25-ohm rheostat placed in the filament circuit of the r.f. tube, and is mounted on the panel along with the channel selector switches. The antenna series condenser should be adjusted for the best selectivity consistent with good volume.

After all three channels are adjusted to resonance, it may be found after an hour or so that they are slightly out of tune, due to the compression of the dielectric in the variable mica condensers. But by adjusting them once more no further adjustments will be needed. If one station is much weaker than the others, due to being of lower power, or more distant than the others, it can be adjusted to maximum volume by carefully tuning the two transformers, and then the settings for the antenna coil. Other channels having more powerful stations can be adjusted slightly off the resonant point, so as to cut down the volume to that obtained from the weakest station.

Note that the switch contacts are at the filament end of the tuning condensers. If they are placed at the grid end, body capacity when operating the switches will be excessive, and may interfere with reception. If more than one channel switch is turned on at one time, the condensers will be placed in parallel, and the circuits will be tuned to some lower frequency which may be outside of the broadcast band. At any rate, the arrangement is intended so that only one switch is operated at one time.

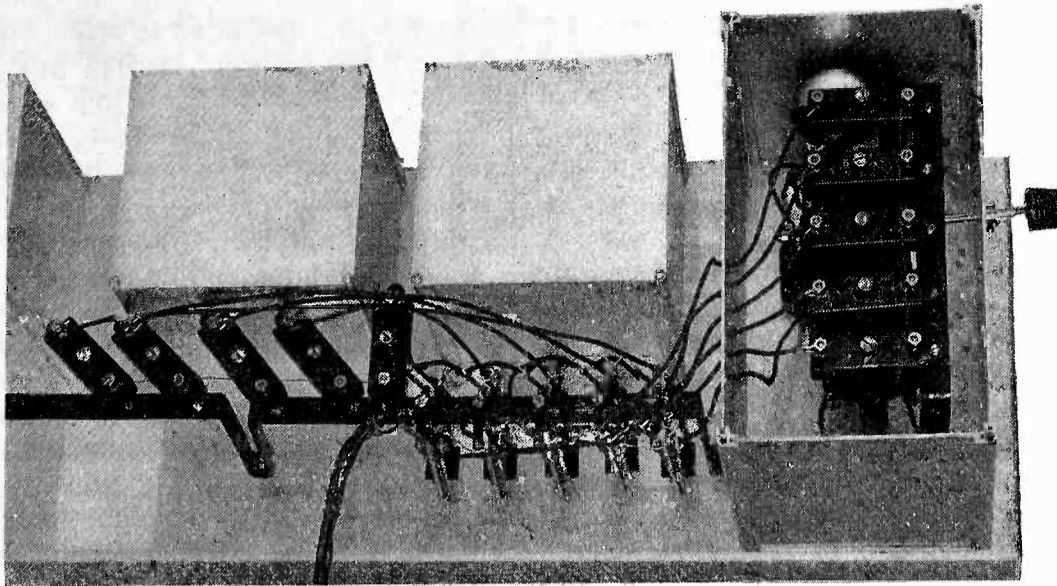

View of Remotely Controlled Receiver showing Relay and Condenser Equipment

An interlocking key assembly such as is used in office telephone installations or apartment houses, where when one key is operated any of the other keys which may happen to be in position are automatically released, would be a refinement of the single switch idea. Keys strips of this sort can be obtained at any telephone supply house.

Above each channel switch the call letters of the station operating on that channel can be engraved on the panel. Or a small designation strip in which a cardboard tab can be inserted will enable the changing of call letters in case one station is to be discontinued, and another one tuned in. In the original model, a pair of variable air condensers with 2 in. dials was located inside the cabinet, with an auxiliary switch whereby they could be temporarily cut in the circuit, so that if there was some special program from a station not ordinarily received with the selected channels, it could be tuned in by adjusting the calibrated dials.

For a receiver having one stage of tuned r.f. amplification as in Fig. 1, a double pole-double throw jack switch is required. With a two stage tuned r.f., a six-spring switch having three separate pairs of springs is needed. This switch is a standard parts item, as is also an eight-spring model which would be necessary for a three-stage r.f. receiver.

An interesting elaboration of the automatic receiver is the remote controlled model, which is more complicated, but offers an opportunity on the part of the experimenter to show his ingenuity and skill. This type of receiver consists of a master switch and volume control located at one point, such as the living room of the home, with the radio receiver, power plant, and control relays located in some other room, such as the attic or cellar. The first one of this type which was constructed by the writer was a superheterodyne which was installed in the home of an invalid who could not operate the tuning dials, so that it was necessary to provide some simple means for turning the set on and off from the invalid chair, and also to be able to select three of the best local stations at will. A

set of four lift type switches was installed on the arm of the chair. These switches operated four relays inside the receiver, one relay turning on the filaments of the set, and the other three tuning the oscillator by means of adjusted fixed condensers so that any one of the three stations would come in with the required volume. An aperiodic antenna circuit was used instead of a loop.

A better scheme is shown in Fig. 2, for the same type of receiver as in Fig. 1. Selection of any one of seven channels is accomplished by a master switch, which operates a bank of relays associated with the receiver. To receive a station, it is only necessary to turn the switch from the "off" position to any of the call letters marked on the switch dial, when the station immediately is heard in the loud speaker, if it is "on the air." The master switch consists of two Yaxley inductance switches with their shafts in tandem, one set of contacts being used to control the station selector relays, and the other set being multiplied together to control the main power relay, which turns on the filament and a.c. circuits. In the diagram, the contacts are shown in pairs, these representing adjacent contacts on the two switches when the arms are set in line with each other. As can be seen from the diagram, when the switch is set at Channel 1, the circuit from the negative A battery through the relay marked "Power" is closed, causing the contacts of the relay to make, lighting the filaments of the tubes, and turning on the a.c. supply to the B eliminator. The other contact made by the switch arm operates the relay associated with Channel 1 and tunes the receiver to the frequency of the station selected for that channel. When the arm is turned to Channel 2, the "Power" relay still is held in operating position, as the switch contacts controlling that relay are connected in multiple, but the relay of Channel 1 is released, and that of Channel 2 is operated. The same is true for the remaining channels, only four of which are shown in the diagram, for the sake of simplicity.

As both sets of tuning condensers are connected to the negative filament circuit, through the contacts of the relays, two of the four contacts of each relay are connected together and grounded, so that the tuning condensers are connected to the remaining pair of contacts. The relays should operate positively on 6 volts, and to be economical of operation should not draw more than 100 milliamperes. There are a number of suitable telephone relays on the market, made either by the Western Electric or Kellogg companies, which will work on 6 volts. A good Kellogg type is the 28-A, which has a d.c. resistance of 100 ohms. The E-322 Western Electric has the same number of contacts, with 120 ohms resistance. Of course the ordinary radio store will not carry these relays, which must be ordered through a telephone supply house, usually located only in the largest cities. The picture shows a group of these relays, with the regenerative r.f. stage and its associated tuning condensers housed in an aluminum

box shield, the other shields enclosing the antenna coil and the r.f. tube.

Unless an auxiliary switch to turn on the 110-volt a.c. is used, it is necessary to use a storage battery in connection with this type of receiver, as the relays require a source of d.c. for operation. An *A* eliminator can be used if a switch to turn it on is located on the panel with the selector switch. The volume control is a 25-ohm rheostat which controls the filament of the r.f. tube. A 4-ohm fixed resistor prevents the overloading of the filament in case the volume rheostat is turned on full.

The wiring which connects the master switch and volume control with the apparatus upstairs is cabled into compact form. If it can be drawn through a piece of metal conduit, so much the better, so that no a.c. induction can be picked up in the filament wiring, due to proximity to house lighting circuits. The output of the power amplifier is brought downstairs by grounding one side of the secondary of the output

transformer to the negative *A*, and bringing the other wire in a separate lead, outside the cabled relay wires. This is not absolutely necessary in Fig. 2, but was required in the installation described because the audio amplifier was also used to amplify the output of the phonograph pick-up. If the input and output leads to the amplifier were in the same cable form an audio frequency oscillation would render the set inoperative.

Several installations of this type have been made by placing the selector switch and volume control knobs on a small brass panel the size of a flush-plate used in a wall type snap switch, and mounting this plate on the wall of the room, bringing the cabled wires to the switch between the walls, so that no wiring will be visible. An electro-dynamic loud speaker unit is then placed in the wall, as was described in May RADIO, and a set closely approaching the ideal, as regards simplicity and convenience, is thus obtained.

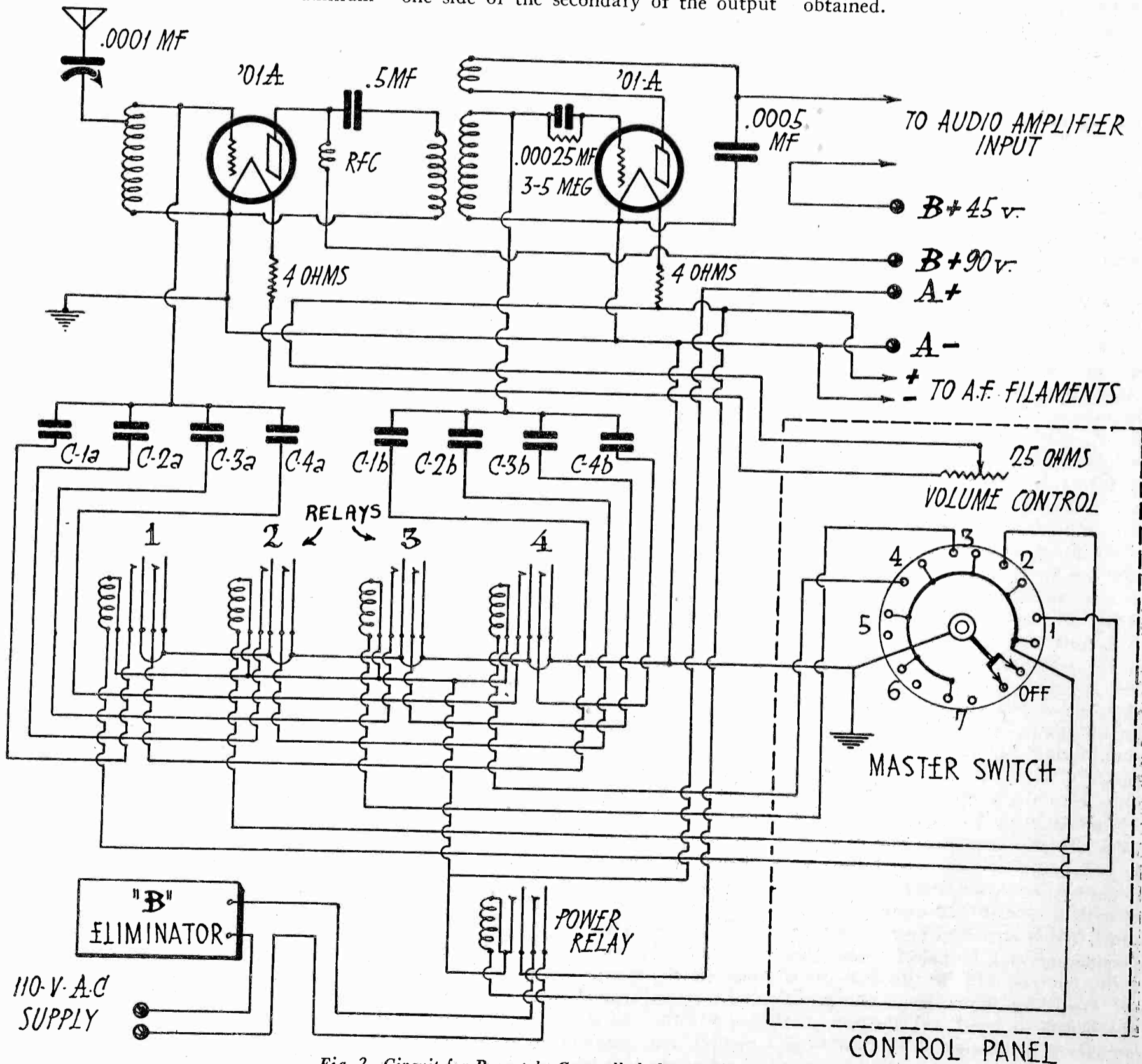

Fig. 2. Circuit for Remotely Controlled Automatic Receiver

A Homemade Photo-Electric Cell

Directions for a Simple Process of Construction Involving a Minimum of Laboratory Equipment and Knowledge

By JOHN P. ARNOLD

THERE are two classes of light-sensitive cells. One group includes the photo-resistances of which the selenium cell is an example. Such devices show variations in their electrical conductivity under the influence of light; but, while extremely sensitive, their action is not so rapid as might be desired and they are usually subject to "fatigue." These limitations are quite detrimental, especially when the cells are employed in systems of visual communication or for talking moving pictures.

Therefore, the alkali metal photoelectric cell, which is representative of the other group of light-cells, has proved more satisfactory for these and other purposes, not being encumbered with the defects mentioned. While these cells have certain disadvantages, particularly in that they are not as sensitive as the photo-resistances, this fault has been overcome using the thermionic vacuum tube to amplify the photoelectric current. With their practically instantaneous response they represent the best present development in devices for converting light energies into electrical currents.

The practical photo-cell consists essentially of an evacuated bulb containing two electrodes—a cathode, composed of an insulated, light-sensitive material (usually of potassium or sodium), deposited on the inner walls of the inclosing glass envelope, and a centrally located anode or positive electrode. With a voltage applied across these terminals and the cathode illuminated, electrons are emitted from the surface of the latter by the action of the light and constitute a convection current through the cell. If proper attention is paid to the design of the cell, the current output is directly proportional to the intensity of the illumination over a wide range of values. The current is unilateral, or direct, and will vary in magnitude with fluctuating light intensities. Most of the applications of photoelectric cells are based on these properties and in time the cells themselves are quite likely to be of the same value to the experimenter as the ordinary radio tube.

The potassium hydride photoelectric cell, such as may be obtained in the market today, cannot be constructed with the facilities of the average radio experimenter. These cells are evacuated by highly efficient mercury pumps working through liquid air traps. The potassium is prepared by multiple distillation and the utmost care is taken to prevent contamination before and after being intro-

duced into the pumping system. During evacuation the cells are usually baked in an oven at a temperature of about 400 degrees Centigrade to assist in removing occluded residual gases. Thus it is easy to recognize that such methods are unsuitable for the possessor of a small experimental laboratory.

Fortunately there is a way of depositing pure sodium within a glass bulb by electrolysis, the sodium being driven through the glass walls of the tube. Such a method is employed by Dr. Robert C. Burt, of Pasadena, Calif., who makes a commercial cell of this type, and it combines utter simplicity of structure with the best qualities of photoelectric cells made by any other process.

A 40- or 60-watt tungsten filament incandescent lamp provides the essential material which enters into the manufacture of the cell. The bulb must be of soda glass, instead of pyrex, of which the majority of incandescent lamps are now made. There will be no difficulty in obtaining this old style of lamp and it is emphasized that this is a case where substitutes will not serve the purpose.

The structure of a completed cell is

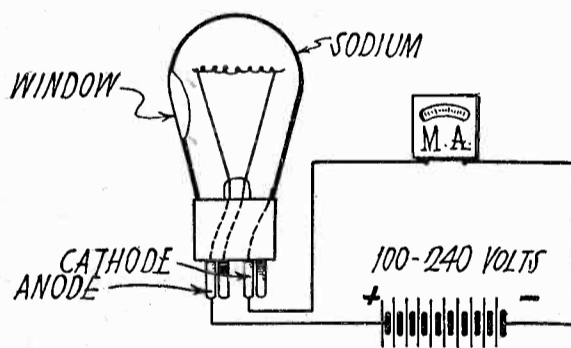

Fig. 1. Photoelectric Cell Circuit
Courtesy of Jour. Opt. Soc. Am.

shown in Fig. 1, showing it in a series circuit with a micro-ammeter and a source of potential. The sodium covers the inner walls of the bulb with the exception of a small area of clear glass (the "window," it is often called) which allows light to fall on the tungsten filament or anode, which is of the positive potential while the sodium is negative. The action is similar to that of the two-element vacuum tube: electrons being emitted from the cathode when it is illuminated by light of short wavelength and, attracted by the positive potential of the tungsten wire, comprise an electric current between these electrodes. This will be noted by a deflection of the pointer of the micro-ammeter.

At the outset there is a difficulty, and only one, which may trouble the con-

structor. The ordinary electric lamp does not have a third wire leading out of the glass bulb which can be used as an external terminal for the sodium surface. Since the necessary pumping equipment is probably not available to the experimenter, several of the lamps should be taken to a laboratory or to a radio tube manufacturer who will seal-in a contact wire and evacuate the bulb for a small charge. It will make a neat job if the wire is taken out somewhere near the neck, and the base of a radio tube substituted for the standard Edison screw type, as shown in Fig. 1. If this is done, each of the filament leads should be soldered to separate prongs of the radio base; for the filament is lighted during the electrolytic process, although it is not when the cell is in operation.

There is another solution to this problem, however, and, although not as satisfactory as the foregoing, the work can be done by the experimenter himself. If alternating current potentials are applied to the terminals of the cell, it is obvious that an electrostatic coupling can be obtained if the cell is inclosed in a close-fitting metal case, which forms one plate of a condenser with respect to the sodium. Such a casing can be made with thin sheet metal and cut out to let light through the "window" into the cell.

A simple way of distilling sodium in the bulb by electrolysis is shown in Fig. 2. The filament leads are unsoldered, from the lamp and the base is removed by heating. The bulb is then inverted in an iron crucible containing molten sodium nitrate which is held at a temperature of 312 degrees Centigrade in a Bunsen flame. A rheostat, milliammeter, and the electrode *E* (a piece of heavy copper wire) complete the setup. A connection may be made directly to

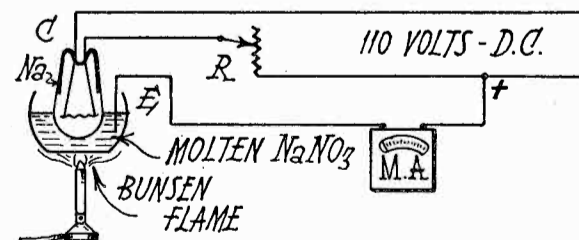

Fig. 2. Simple method of distilling Sodium in the Bulb
Courtesy of Jour. Opt. Soc. Am.

the iron crucible instead of to a separate electrode. The filament of the lamp is lighted from a 110 volt source of supply and the resistance of the rheostat decreased until the filament begins to emit electrons, which are attracted by the molten sodium nitrate. At the inner side

of the glass bulb, the electrons neutralize the sodium ions in the glass. These combine to form sodium atoms which are deposited on the cooler walls of the bulb. The nitrate constantly supplies sodium ions to the inner surface of the glass where the combination takes place.

Once a sufficient amount of sodium is inside the lamp, it may be redistilled to any part of the bulb which is most convenient for the operation of the completed cell. This is done by gentle heating to drive off the sodium and deposit it where the walls are cooler. In a similar manner heat is applied to the place which is to serve as the "window." The tungsten filament is also lit during this process to prevent the deposit of sodium upon it, which, in that event, would show a reverse photoelectric effect.

Several objections are to be found with this elementary circuit, namely: (1) one side of the filament is likely to become overheated by carrying excessive current, and (2) the whole bulb may get so hot that ionization of the sodium vapor takes place between the ends of the filament with the possibility of burning it out and hence ruining the cell. These difficulties are overcome in the

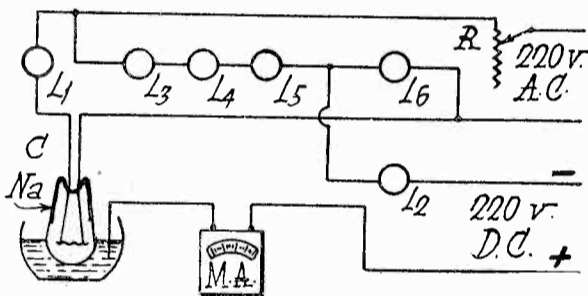

Fig. 3. Better Method of Distilling Sodium
Courtesy of Jour. Opt. Soc. Am.

circuit arrangement of Fig. 3, where incandescent lamps serve as series resistances to limit ionization currents and the electrolytic field is applied between the center of the filament and the sodium nitrate. The lamps, indicated as L_1 and L_2 in the diagram, tend to suppress ionization currents and the other lamps, all alike, are connected in series across L_1 and C and are employed to find the midpoint of the filament.

By this latter arrangement currents as large as .3 amperes can be used, which result in the deposit of about 300 milligrams of sodium per hour, using a 60-watt, 110-volt lamp. It would seem possible to employ potassium or some other alkali metal for this electrolytic process, but Dr. Burt has found that this cannot be done successfully. The potassium ions, for instance, are evidently less mobile than sodium ions in soda glass. In the case of lithium, the bulb is completely ruined within a few minutes and is no longer capable of holding a vacuum.

A word of caution is inserted here with regard to the heating of sodium nitrate. This substance has a large thermal expansion and if first heated by applying the flame to the bottom of the

crucible is likely to spatter and cause rather painful burns. The best way is to hold the Bunsen burner near the side of the crucible and when the sodium nitrate is thoroughly heated, it may then be placed underneath without subsequent danger of spattering. Care should also be taken that water does not fall into the molten salt.

Commercial sodium nitrate is easily obtainable and in this state is suitable for the process. Uncontaminated sodium surfaces are thus readily prepared and a cell of this type, carefully made and designed, is quite likely to be as good, if not superior to others where the alkali metal must be first purified before introduction into the bulb. This is true providing the bulb is highly evacuated and minute traces of impurities which may be absorbed within the bulb have been removed.

The applications of photoelectric cells for experimental and commercial purposes have been set forth in this magazine at different times during recent years and there is no doubt in the future that these devices will be used for other purposes which are of particular interest to radio experimenters. It is out of place here to catalogue the uses to which these cells may be put, although the construction of a sodium cell as described above might be considered as a first step in acquiring a knowledge of their applications and once the principles of the cell are understood, many uses will suggest themselves to the reader.

VAGARIES OF THE ETHER

By WALLACE KELK

SOME interesting contributions have been made to the study of electromagnetic propagation at the Pachena Point, B. C., station of the Canadian Radiotelegraph Service. The results show an amazing difference between the stability of 800 meter signals traveling entirely over water, as compared with those traveling over land during the night. The observations were taken on

Gonzales Hill, 75 miles southwest of Pachena Point, and on Bull Harbour, 150 miles northwest, both distances being overland.

The tests consisted of a twenty-four hour series of hourly radio-compass readings on the transmission of two-minute signals from each station. The tests between 7:30 p. m. and 11:30 p. m. gave practically the same results as those between 12:30 a. m. and 7:30 a. m., except that, whereas all Bull Harbour tests revealed a negative variation, most of the Gonzales Hill tests were negative for the early morning and positive for the evening observations.

The relative magnitude of the variations are shown in Fig. 1. The zero line represents the true bearings of the station on which observations were taken. The scale of degrees denotes the extent and direction of the variation. An unshaded hump shows one observation, light-shaded two, and heavy-shaded three observations.

Checks for night effect were taken on the Canadian station at Estavan Point and the U. S. Naval station on Tatoosh Island, both signals traveling over water. Then checks showed normal and steady signals over water during the night while there were astounding variations over land.

This difference has been interpreted as being due to a more rapid de-ionization in the Heaviside layer over water than over land after sunset. Difference in ionization is assumed to change the surface that reflects and refracts radio waves, due to vertical polarization. While this causes fading and freaking in ordinary radio transmission, in compass work it causes distorted bearings. Unless frequent checks are taken on known fixed stations, this might mean that bearings given to vessels would be several degrees in error, with possible dire consequences. Fortunately, one of the first effects of night effect is to dull or blur the minimum so that the operator has ample warning.

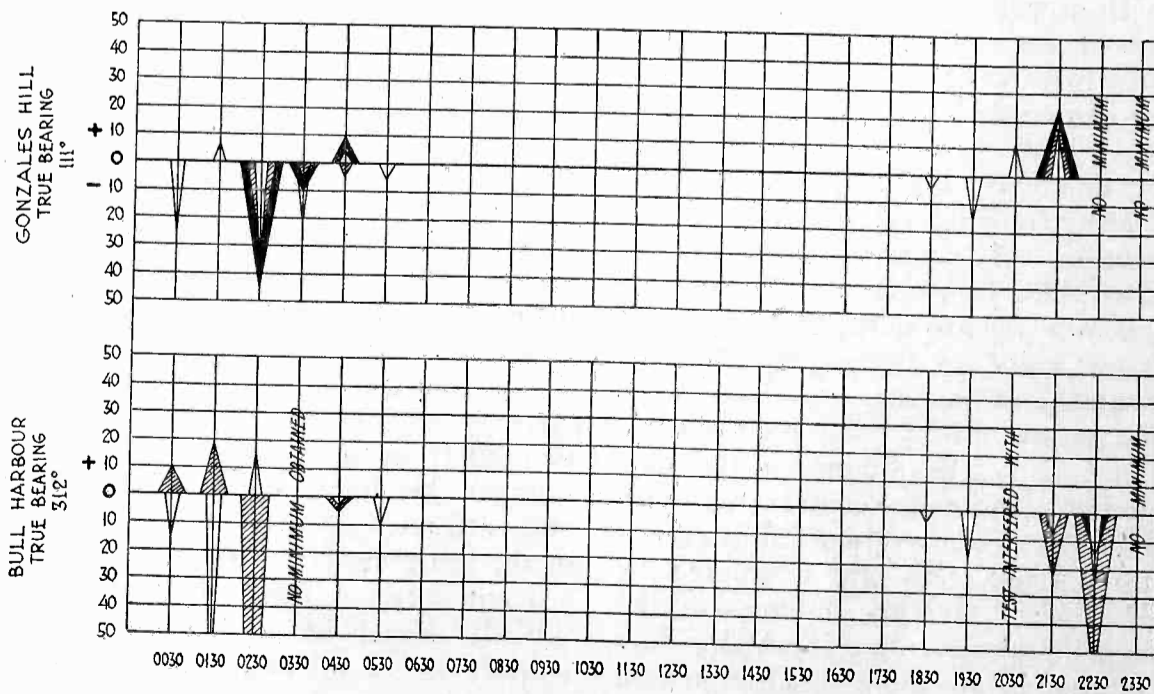

Fig. 1. Goniometric Tests for Night Effect. Notations show where effect is so violent that no minimum was obtainable

An Experimental Six Tube Set

Embodying a Tuned Band Pass Filter Preceding Two Screen Grid R.F. Tubes

By FRANCIS CHURCHILL

A six tube receiver using two stages of tuned r.f. with screen grid tubes, detector, and two stages of audio with push-pull in the last stage gives greater selectivity and sensitivity and better tone quality than the set described by the author in May RADIO, to which it is otherwise somewhat similar. Plug-in coils are used in the r.f. stages and the tuning circuits are especially arranged to give good selectivity with a minimum of side-band suppression. With high quality transformers and two-power tubes in the last audio stage this outfit gives great volume and fine tone quality when used with a dynamic speaker.

From the circuit diagram in Fig. 1 it will be noted that a band-pass filter is used ahead of the first r.f. tube. This tuning circuit has three resonant elements, $L_1, C_1, L_2, C_2,$ and $L_3, C_3,$ all tuned to the same frequency. The ground side is common, and the other side has coupling capacities and in series, these being of the small adjustable "neutralizing" type so that each tuned circuit is practically independent of the next.

One drum dial controls $C_1, C_2,$ and $C_3,$ so as to pass a 10,000 to 15,000 cycle band when the three circuits are tuned to the same frequency. Any undesired frequencies, such as adjacent station carriers, are greatly attenuated. The arrangement can be compared to a per-

fectly balanced Neutrodyne set when the grid-to-plate capacities of the tubes are replaced by condensers, which, of course, give no amplification as do the tubes.

Following this tuned circuit are two stages of screen-grid tubes with tuned impedance coupling, which gives maximum amplification. The pre-tuning takes care of the selectivity. Any stray capacity is shunted by the tuning condensers so that no oscillation occurs in the r.f. stages.

The detector circuit is designed to give practically constant regeneration throughout the broadcast band. A choke coil in the detector plate circuit prevents the passage of r.f. energy so that part of it can be by-passed to ground or negative filament through C_{10} and part of it is fed back to the grid transformer through C_{11} and R_5 . The amount of feedback depends upon the values of the variable C_{10}, C_{11} and $R_5,$ increasing as R_5 and C_{10} are decreased and as C_{11} is increased. By this means less feedback can be produced at high frequencies, and constant regeneration and better selectivity obtained at all frequencies.

The first audio stage is made an integral part of the receiver and the second push-pull stage is built into the plate supply unit whose circuit diagram is shown in Fig. 1. This arrangement keeps

- LIST OF PARTS
- 1 7 x 24 x 1/4" panel
 - 1 7 x 24 x 1/2" baseboard
 - 1 9 x 18 x 1/2" baseboard
 - 1 three gang condenser .00035 mfd. per section C_1, C_2 and C_3
 - 1 special two gang condenser .00035 mfd. per section C_4 and C_5
 - 2 drum dials
 - 5 copper cans 3 x 5 1/2 x 5 3/4 inches
 - 5 plug-in coils (see text)
 - 12 UX sockets
 - 1 high quality 3:1 ratio audio transformer
 - 1 push-pull set of transformers
 - 1 200-volt "B" eliminator block (transformer and 2 chokes)
 - 2 r. f. chokes 1 1/2 millihenrys
 - 1 r. f. choke 85 millihenrys
 - 2 1/2 mfd. bypass condensers C_{12} and C_{13}
 - 1 2 mfd. bypass condenser C_{14}
 - 1 "B" eliminator condenser block of 14 mfd. total (DC working voltage 200)
 - 1 fixed resistance 7500 ohms 25-watt size
 - 1 fixed resistance 15000 ohms 25-watt size
 - 1 variable resistance 25000 ohms 25-watt
 - 1 variable resistance 2000 ohms 25-watt
 - 3 20-mmf maximum variable condensers
 - 1 .001 mf mica condenser C_8
 - 1 .00025 grid mica condenser C_9
 - 1 .001 semi-variable condenser C_{10}
 - 1 .0005 semi-variable condenser C_{11}
 - 1 20-ohm volume control rheostat and filament switch R_3
 - 1 0-10,000 ohm variable resistance R_5
 - 2 20-ohm center tapped resistances R_1 and R_2
 - 1 automatic filament resistor R_4 (1/2 amp.

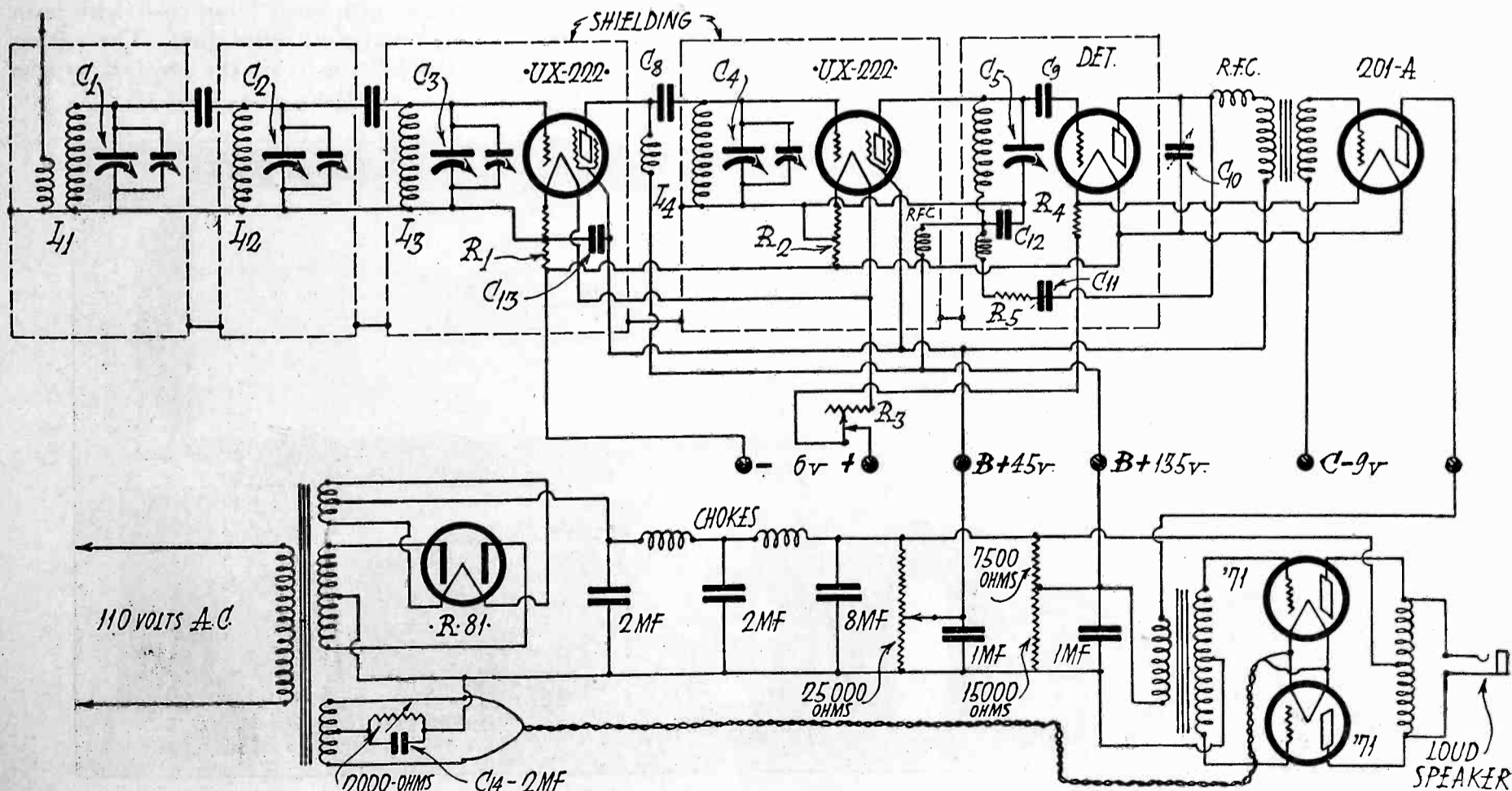
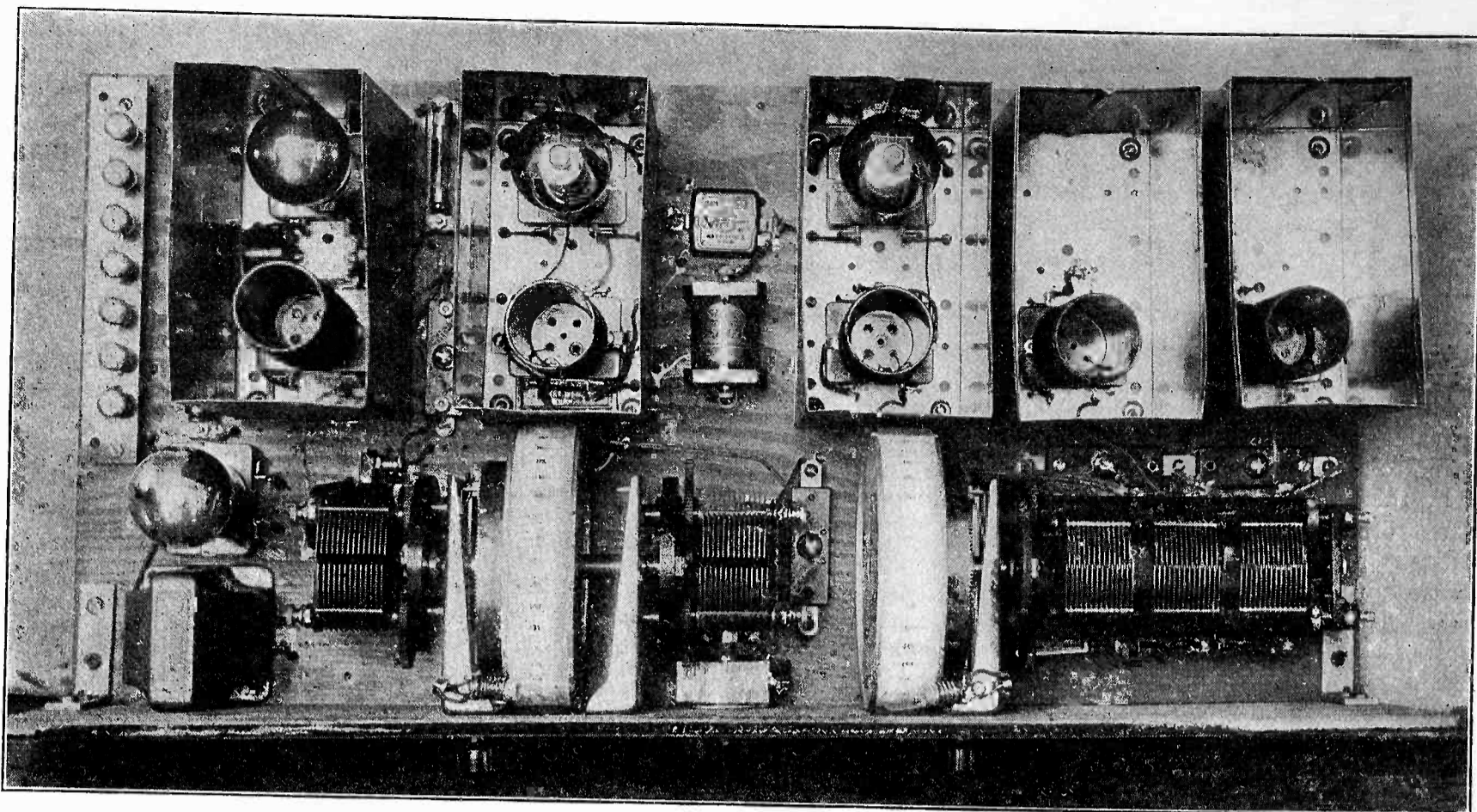

Fig. 1. Circuit Diagram for Set with Shield-Grid Tubes



Top View of Experimental Set with Two Shield-Grid Tubes

all a.c. leads away from the main part of the receiver, a.c. being used on the filaments of the power tubes.

An experimental layout is shown in the pictures, and can be duplicated for such other parts as may be used by the constructor to conform to the constants given in the list of parts. The author used a $7 \times 24 \times \frac{1}{4}$ in. panel and $7 \times 24 \times \frac{1}{2}$ in. baseboard for the receiver and $9 \times 18 \times \frac{1}{2}$ in. baseboard for the power unit. The five can shields are mounted as shown with the wiring passing through the baseboard. These cans may be drilled for mounting the r.f. chokes and two sockets with by-pass condensers beneath them, or may be bought already drilled.

The coils are of the plug-in type to fit a standard socket with the secondary

winding connected to the large prongs and the primary, if any, to the small prongs. The secondary is split into two windings of 60 turns each on $1\frac{1}{2}$ in. diameter, the grid and filament leads being made from the center of the windings instead of the ends of the solenoid.

The primary coils are removable and can be secured with a different number of turns, or wound if necessary. The primary of the first coil has 7 turns. The detector plate coil has 40 turns, wound so as to cause regeneration when plugged into its socket. If it does not do so, its leads to the socket should be reversed.

The filament resistances R_1 and R_2 are of 20 ohms with a center-tap for providing the correct control-grid potential of about $1\frac{1}{2}$ volts. This does away with an additional C battery. The loca-

tion of these resistances and other miscellaneous parts is immaterial.

The power amplifier and B supply unit has a wire wound variable resistor of 25,000 ohms for the 45 volt tap, and two fixed resistances of 7500 and 15,000 ohms for the 135 volt tap. There is no need to use a 90 volt ballast or tube in this eliminator. The second variable resistor of 2000 ohms is used to obtain grid bias for the two 171 power tubes. The B eliminator supplies considerably over 200 volts on the highest tap if a filament type full wave rectifier tube is used and so will supply C voltage also. The wiring of this part of the set should be done with good lamp cord with both rubber and cloth insulation. The wiring of the other part of the receiver can be

(Continued on Page 34)

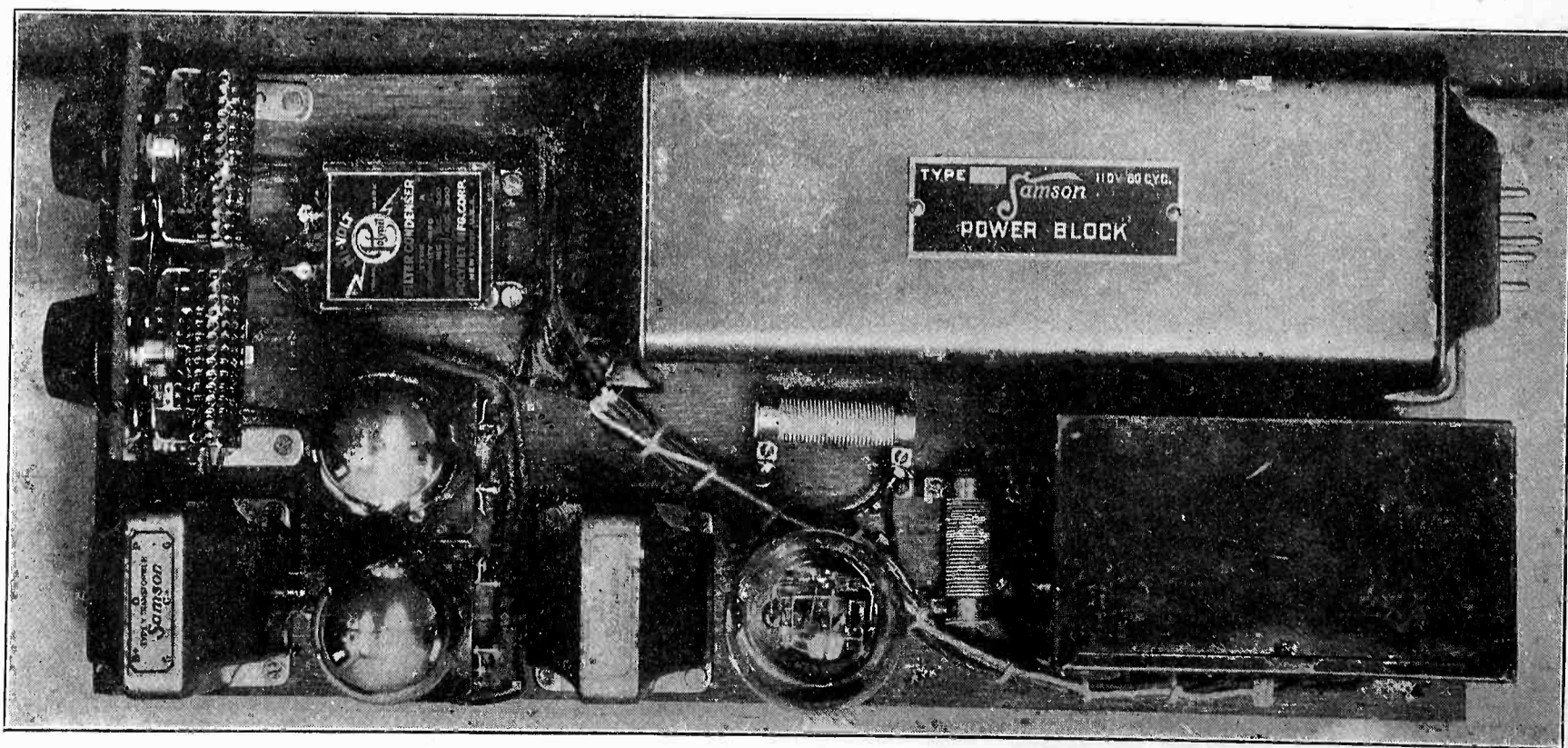

Plate Supply Units and Push Pull Amplifier

Resistors for Voltage Dividers

By HOWARD FIELD, JR.

To design a voltage divider to give the correct *B* voltages from a rectifier and filter is a simple task, though somewhat tedious. It can be done by the cut-and-try method on paper much more cheaply than by buying a flock of resistances and shaking them up in a hat.

Rectifier manufacturers publish curves which show the voltage impressed across the filter output terminals for various current drains and applied voltages. Fig.

The plate current drains of the standard tubes are given in the table published herewith. But remember that a tube draws more than its rated current unless it has the proper grid bias.

The first essential in a resistor is ability to carry the load without overheating. The load in watts is equal to the square of the current in amperes multiplied by the resistance in ohms. So if a 5000 ohm resistor is to carry 80 milliamperes it should have a capacity of $.080 \times .080 \times$

sistor arrangements, one of which showed a drop of 24 volts in detector voltage for a change of .1 milliamperes in plate current whereas with this arrangement the drop is only 0.8 volt from 40 volts.

Most manufacturers furnish resistors in stock sizes for 200, 300, 400, 500, 750, 800, 1000, 1250, 1500, 2000, 2250, 2500, 3000, 3500, 4000, 4500, 5000, 6000, 7000, 7200, 7500, 8000, 9000, 10,000, 12,000, 15,000, 20,000, 25,000, 30,000, 40,000, 50,000 and 100,000

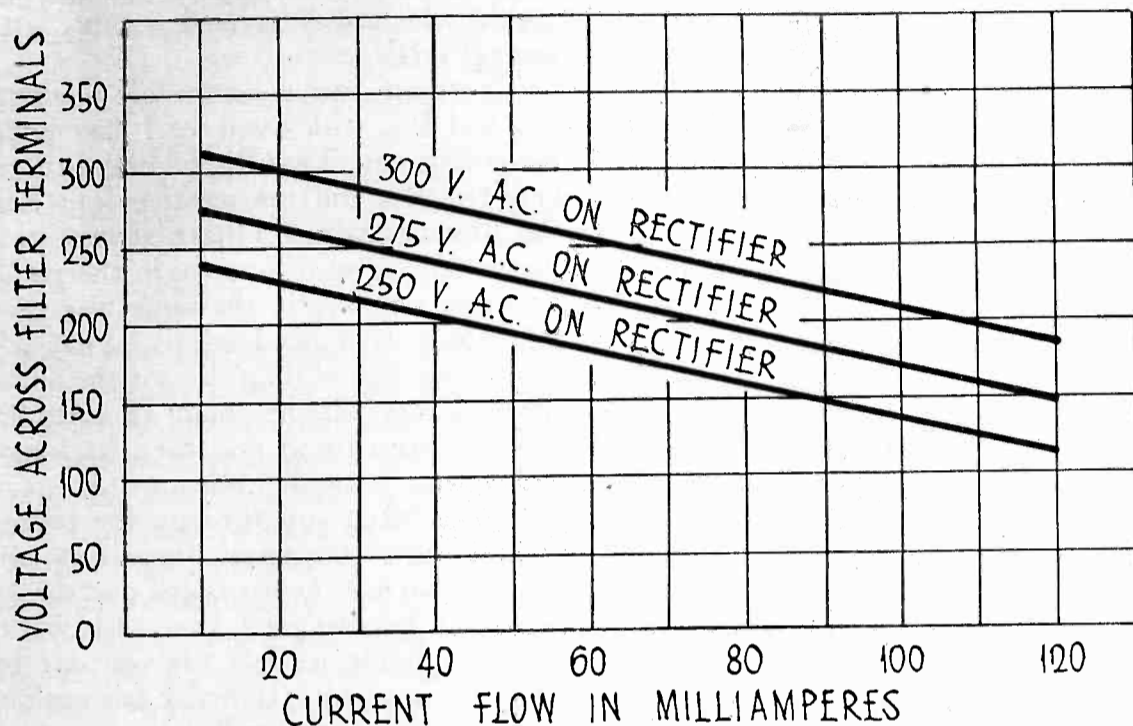

Fig. 1. Voltage regulation of Raytheon 125 m.a. Rectifier

1 gives such data for a Raytheon 125 milliamperes rectifier. Fig. 2 likewise shows the voltage delivered to the filter input by a 380 tube at various load currents, the output voltage being determined from the filter resistance. Thus it is simple to learn what is the maximum voltage obtainable for a given current drain.

5000=32 watts, which is an odd size. So take the next larger size of 40 or 50 watts, depending upon the make, as trouble will almost surely develop from using a smaller size.

The best arrangement for the resistor is that shown in Fig. 3, which gives a more nearly constant voltage for load changes than do some of the other re-

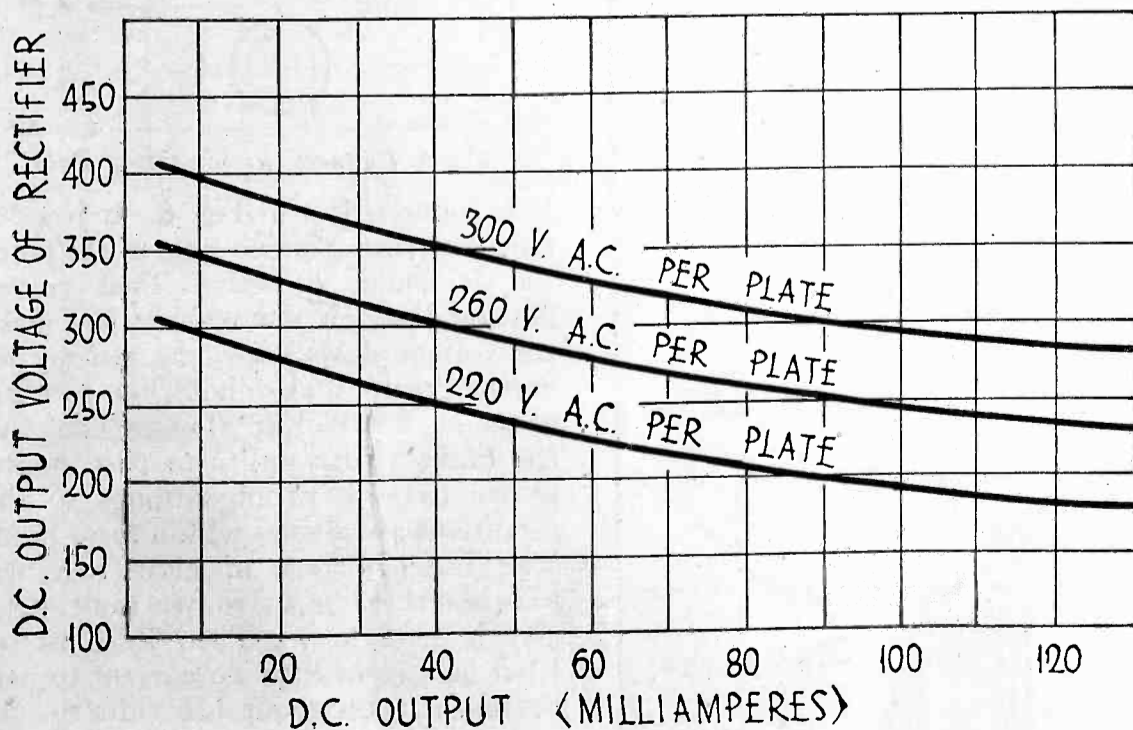

Fig. 2. Voltage regulation of 380 Tube

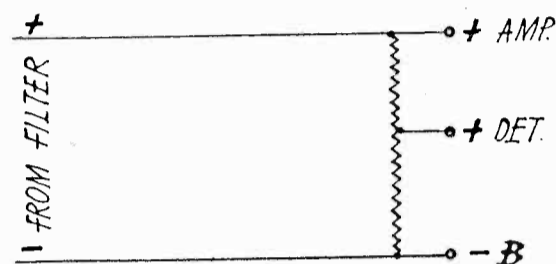

Fig. 3. Recommended Resistor Arrangement

ohms. Various manufacturers make these in 10, 20, 30, 25, 40, 50, and 75 watt sizes.

An extreme example of current drain requirements is furnished by a nine-tube superheterodyne having as the r.f. amplifier an A tube taking 2 m.a. at 90 volts, an oscillator taking 1 m.a. at 45 volts, two detectors each taking 1½ m.a. at 45 volts, three screen grid tubes each taking 1½ m.a. at 135 volts, a low impedance A tube as first audio taking 3.5 m.a. at 90 volts, and a power tube drawing 20 m.a. at 180 volts. Furthermore the unit is to supply 40½ volts negative *C* bias.

Fig. 4 is a sketch of the voltage divider to be designed for use with transformer which supplies 300 volts to the rectifier. The voltage and current requirements for the superheterodyne are shown at the various taps on the diagram, the current in milliamperes appearing within parenthesis.

The total voltage across the divider should be $180 + 40.5 = 220.5$ Fig. 1

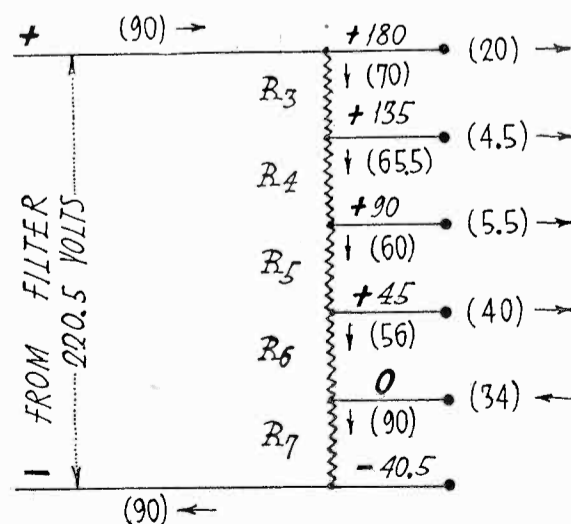

Fig. 4. Preliminary sketch for Voltage Divider

shows that with 300 volts on the rectifier that the maximum requirements of 90 m.a. may readily be drawn at this voltage. Of the 90 m.a. from the filter, 20 m.a. go directly to the power tube, leaving 70 m.a. to flow in R_3 . The three screen grid tubes draw out 4.5 m.a. at the 135 volt tap, leaving 65.5 m.a. flowing in R_4 . The two A tubes draw out 5.5 m.a. at the 90 volt tap, leaving 60 m.a. to flow in R_5 . The detectors may draw 4 m.a. at the 45 volt tap, leaving 56 m.a. in R_6 . The lower end of R_6 is the negative B lead where all the current which left to go through the tubes comes back, so that through R_7 we again have 90 m.a.

In view of the possibility of some time adding a glow tube to maintain a 90 volt output from R_4 , it is first advisable to figure the combined resistance of R_3 and R_4 to give a nominal 90 volts. As these carry almost the same current and as we are limited to the choice of standard resistors, we will use the same sizes for R_3 and R_4 .

If you do not want to take my word for this, and I should advise you to take nothing on faith, you might try some figures for yourself. If they are alike we can consider that the mean between 70 and 65.5 or 67.75 m.a. flows all the way through R_3 and R_4 so as to find out their total resistance. The way I make it 90 divided by .06775 gives 1328 as the total. Hopeless. There are no resistances which will add up to this figure. Well, we will try two 750 ohm resistances. That comes to 1500 ohms and with 90 volts drop and the help of Ohm's law we see that the average current will be 60 m.a. That means that the filter would have to turn out

a little more than 80 m.a. and we see from our curves that when it does the voltage across it is about 230. That is not so hopeless.

Let's make a new diagram like Fig. 4 except that we will put in the final answers as we go along. Call this Fig. 5,

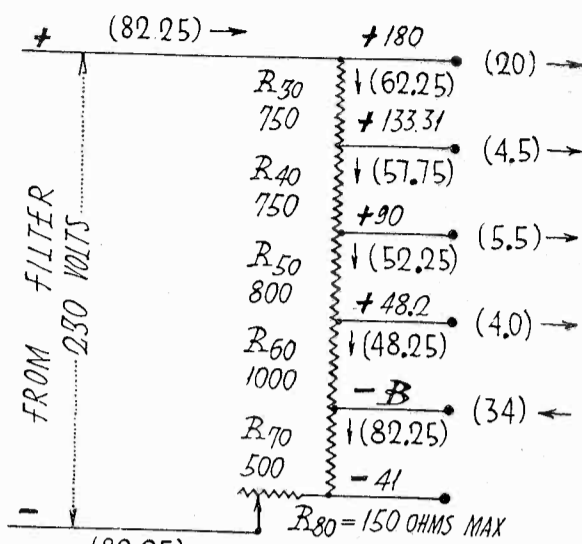

Fig. 5. Final sketch for Voltage Divider

and to avoid confusion use R_{30} for R_3 , R_{40} for R_4 , etc. On this new diagram we can now write in R_{30} equals 750 ohms and R_{40} equals 750 ohms. If the mean flow is 60 m.a. and we have 4.5 going out at the mid point, then there must be 60 plus 2.25 or 62.25 m.a. flowing in R_{30} and 82.25 m.a. coming from the filter so we will write those values in their places.

Then Mr. Ohm tells us that the potential drop in R_{30} is 46.69 volts or the tap voltage is 133.31 instead of the nominal 135. That slight difference will make no trouble. In R_{40} there is 57.75 m.a. current and 750 ohms resistance so we see that the drop in it is 43.31 volts,

which brings the tap at exactly 90 volts as we figured.

With 5.5 m.a. leaving at that tap there will be 52.25 m.a. flowing in R_{50} . There should be about 45 volts drop in this resistor so if we had to have perfection we should need an 861 ohm resistor. Again, this is not a standard size so we might use one of 800 ohms. That will give a drop of 41.8 volts across it and 48.25 m.a. of current through it. We see immediately that 1000 ohms is the right value. The odd .05 m.a. can be disregarded because the errors in the resistors and the variation in the tubes is so much greater that such a small error is negligible. I will admit that this did not happen to come out so closely the first time and I have given you the final result which was arrived at only after several trials.

There are two resistors left to figure, R_{70} and R_{80} , which you see I have added to the diagram. That R_{80} might go in either between R_{30} and the positive lead from the filter or where I have shown it, as there will be no difference in the result. Figuring out R_{70} in the same way gives 500 ohms as a good value. That will give a negative of 41 volts for the power tube. There will be about 10 volts left over to take care of and for that I have added that variable resistance R_{80} .

I have taken you through the process of arriving at the resistance values, and have shown you how to pick out the capacity resistor required, so you had better go through the process for yourself for one to fit your set. It really has nothing to do with the voltage divider but when you come to building that B -supply do not forget that you must put in good big by-pass condensers from every tap to the minus B connection, 1 mfd. a piece is none too large.

A glow tube is a great help in keeping the output of the B -supply constant.

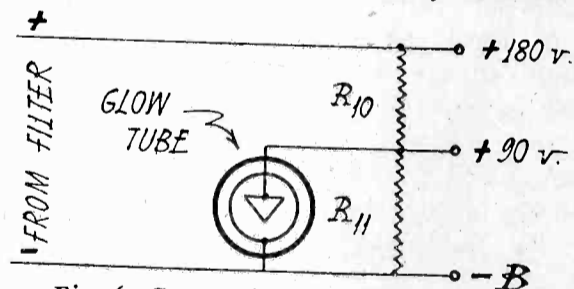

Fig. 6. Connections for Glow Tube

It is connected as in Fig. 6. It lets current flow through it so long as the potential is above 90 volts. That current flowing through the resistor R_{10} makes the voltage drop across the resistor terminals greater and so holds the potential of the tap constant at 90 volts. The tube has limits to its ability to pass current so we have to arrange things so that conditions are always within these limits. The UX-874 type of glow tube will pass about 45 m.a., so we must never give it more to do. Then we must not let it go out, or have no current to pass, because it takes about 125 volts to start

(Continued on Page 38)

PLATE CURRENT OF VARIOUS TUBES

ALL CONSIDERED AS HAVING PROPER GRID BIAS FOR THE PLATE POTENTIAL

	AS DETECTOR		AS AMPLIFIER					
	Plate Volts	Plate Curr. Mills	Plate Volts	Plate Curr. Mills	Plate Volts	Plate Curr. Mills	Plate Volts	Plate Curr. Mills
Dry Cell Type CX-299, UX-199	22-45	0.4-0.9	45	0.7	67	2.2	90	2.5
5 Volt Gen. Purpose CX301A, UX201A	22-45	1.0	90	2.0	135	2.5		
A C Filament Type CX326, UX226 C 327, UY227	45	1.5	90	3.7	135	3.0	180	7.5
			90	3.0	135	5.0	180	6.0
Special Detector CX300A, UX200A	45	1.5						
High MU Types CX340, UX240 CECO G			90	0.3			180	0.7
			90	1.0			180	1.8
Screen Grid Types CX322, UX222 Screen grid at 45V.			90	1.4	135	1.5		
Power Types CX 220, UX 120 CX 112, UX 112 CX 371, UX 171 CX 310, UX 210			90		135	6.5		
					135	5.8	157	7.9
					135	16.0	180	20.0
					250	12.0	425	22.0

Scientific Set Design

A Description of the Methods and Instruments Used by a Manufacturer of Receivers to Determine Their Gain

By RICHARD F. SHEA

Engineering Department, The Amrad Corporation

THE greatest advance in factory production of radio receivers has been the substitution of precise measurement of circuit performance for hit-or-miss design. This includes an investigation of the performance of all the individual parts entering into the construction as well as of the various combinations of these parts.

In commercial practice the usual method is to measure the gain given by a single stage in which the proposed parts have been incorporated. Knowing the performance of one stage makes it possible to visualize the amplification given by the others.

As an example, analysis of a simple five-tube receiver with two stages of unneutralized tuned r.f., detector, and two stages of audio shows it to consist of six elements as follows:

- (1) From the antenna to the grid of the first r.f. tube.
- (2) From the grid of the first r.f. tube to the grid of the second r.f. tube.
- (3) From the grid of the second r.f. tube to the grid of the detector.
- (4) From the grid of the detector to the grid of the first a.f. tube.
- (5) From the grid of the first a.f. tube to the grid of the second a.f. tube.
- (6) From the grid of the second a.f. tube to the loud speaker.

The composite effect of the first three gives the total r. f. gain of the receiver. Gain (4) shows the detecting efficiency and (5) and (6) the total a.f. gain. Gains (2) and (3) are identical, as the same placement of the same parts is used, so that either can be measured separately

and the result squared to show the gain for two stages, or cubed for a possible three stages.

Radio Frequency Gain

To find the total r.f. gain thus requires a determination of (1) and (2), which can be found by putting a known voltage on the input of a single stage and measuring the resultant output. The input may be obtained with a calibrated attenuator and thermo-couple. The output may be measured with a thermionic voltmeter.

Fig. 1 shows the constructional details of a suitable attenuator for single

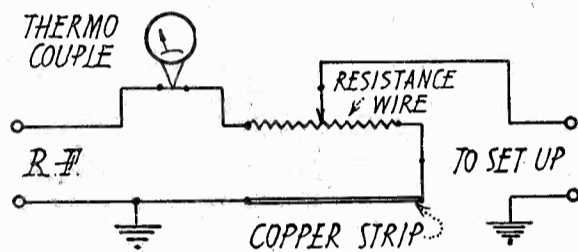

Fig. 2. Wiring Diagram of Attenuator.

stage measurements and Fig. 2 the wiring diagram. It is essentially a low-inductance slide-wire potentiometer made by winding a strip of copper around the edge of the bakelite wheel. The copper

should not form a complete loop, but should extend over about seven-eighths of the wheel surface. Over this copper a piece of paper is glued and then a piece of No. 24 Nichrome wire is stretched around the wheel over the paper. The wire may be held in the center of the paper by originally spinning a groove in the copper strip. One end of the wire is soldered to the copper strip and the other end is insulated from it. The free ends of both the wire and the copper are brought out through concentric shafts, insulated from each other, and contact is made on the back by small plugs. The contact on the slide-wire is obtained through a V-edge spring which is also insulated from the case. Thus the contact is fixed and the wire rotates.

This potentiometer is designed for use with an input current of about 200 milliamperes, and requires a thermo couple of this size. The potentiometer is calibrated directly on d.c. by passing 200 milliamperes through it and measuring the voltage at different positions of the pointer. The output voltage is to be maintained at 1 volt, so that the gain is 1 volt divided by the input voltage. For instance, if at a certain position of the pointer the input voltage is 0.1 volt, then the gain is

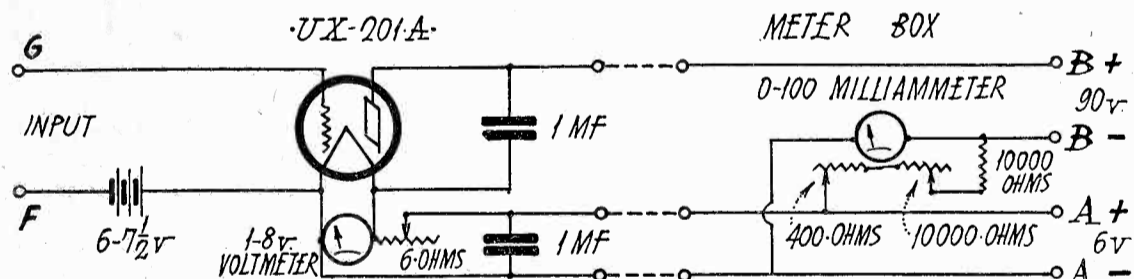

Fig. 3. Thermionic Voltmeter with "C" Battery Rectification

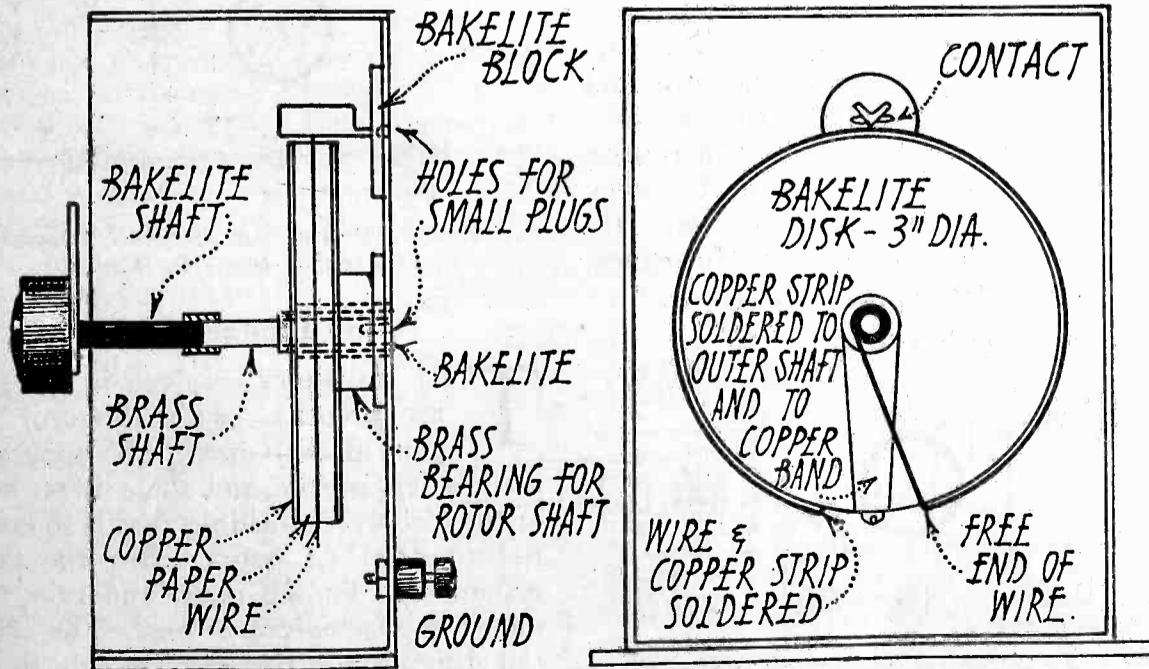

Fig. 1. Constructional Details of Attenuator

10. Other points are similarly marked to give a direct calibration in voltage gain.

Fig. 3 shows a thermionic voltmeter which uses a C battery for rectification and which gives a good deflection with a 100 microampere meter to as low as 0.4 volt. It is made in two parts. One contains the tube and its immediate accessories, voltmeter, condensers, etc. The second part is a small battery box which fastens to the meter and contains the adjusting resistances with which the meter is set to zero. This second box carries the battery cable and has three small phone jacks on the panel, into which is plugged the cable from the tube box. This cable supplies filament and plate voltage to the tube. The rheo-

stat in the tube box holds the voltage at 5 as indicated by the voltmeter.

In using the meters, set the microammeter on its least sensitive scale and adjust R_1 until the meter reads zero. Shift to the sensitive scale and readjust the pointer to zero with R_2 . These adjustments are made with the tube lighted and all voltages applied. The zero will shift as the tube warms up, but will reach a steady value after a short time. When the tube is turned off the meter must be returned to its least sensitive position. Its calibration is independent

is set at a gain of 5, corresponding to 0.2 volt from the attenuator. The current is adjusted until the Type B voltmeter reads 0.2 volts and the thermocouple is read. It will show 200 m.a. at all frequencies if the attenuator is non-inductive. Otherwise it will be necessary to prepare a curve of the proper value of I for each frequency. To measure the gain, the current is set at the proper value and the attenuator is adjusted to 1 volt output, when the gain can be read from the scale.

The first r.f. measurement to be made

stage is obtained at various frequencies. Plotting this gain gives a visual representation of the performance of this stage.

The selectivity of the stage may be noted by leaving the single stage tuned to a certain frequency and then detuning the oscillator until the gain is halved. Repeating this on the other side of resonance and subtracting the two frequencies gives a resonance band which is indicative of selectivity, as the narrower this band the more selective the set will be.

A similar process is used to get the single stage gain of the second and third stages, using the set-up of Fig. 7. Here the r.f. transformer, the tuning condenser, the tube and socket, and the neutralizing system must also be incorporated in order to use all the factors affecting gain and selectivity. In this circuit a Neutrodyne type of neutralization has been shown, but any other system can be used. The procedure is the same as that for measuring the antenna stage and the gain and resonance bands are obtained in the same manner. The total r.f. gain at any frequency may be computed as the product of the antenna stage gain and the gain of each r.f. stage. In using this apparatus it is best to use double shielding, placing the oscillator in one box, then placing this box inside another which also contains the tuning condenser and loading inductance. A sheathed pair of leads will supply power to the measurement set-ups and the external pick up will be nil.

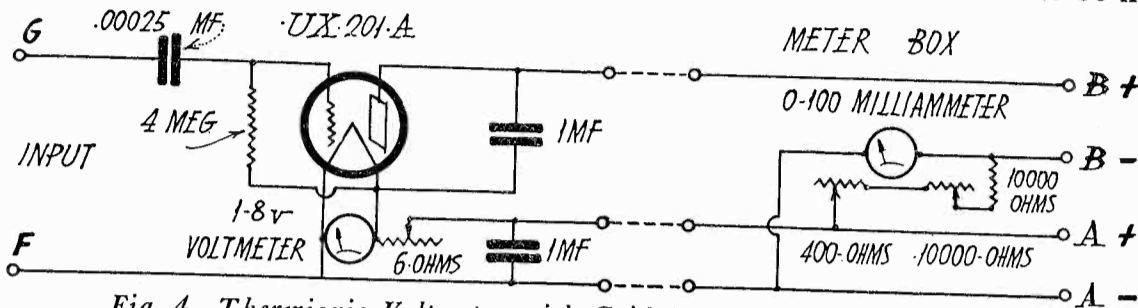

Fig. 4. Thermionic Voltmeter with Grid-Leak Condenser Rectification

of frequency. It may be calibrated at 60 cycles and used safely at 1000 kilocycles. But below $\frac{1}{2}$ volt it gives too low a reading. This can be corrected by adding a $2\frac{1}{2}$ ohm resistance and calibrating with a thermionic voltmeter which has a grid-leak condenser combination for rectification.

Fig. 4 is the diagram of such a voltmeter which uses the same battery box as the C battery type. It is sensitive to

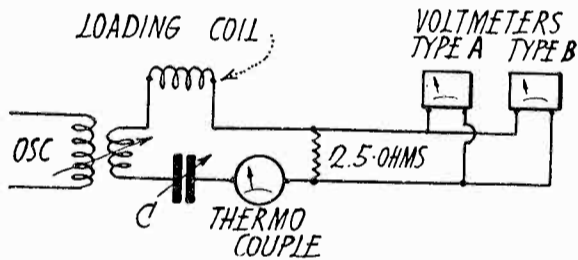

Fig. 5. Circuit for Calibration of Type B Voltmeter

0.1 volt, but has a low input resistance. It is the Type B voltmeter in Fig. 5, whereas the C battery detector is the Type A. Its adjustment and use is similar to that of Type A.

Fig. 5 is the circuit for low voltage calibration of the Type B voltmeter by means of the Type A voltmeter. The oscillator coupling coil is tuned with the loading coil and condenser to give maximum voltage. The Type A voltmeter has previously been calibrated to 60 cycles. The current through R is adjusted until voltmeter B shows $\frac{1}{2}$ volt, when I is read. If R is non-inductive I will be 200 milliamperes, otherwise I will be less. Decreasing I to 40 milliamperes gives 0.1 volt across R , whence the reading of Type B at this frequency can be calibrated. Intermediate values of I give other voltages whereby the grid-leak condenser voltmeter can be calibrated for different frequencies.

The attenuator can be checked by connecting it to the r.f. source in series with the 200 m.a. couple, the Type B voltmeter being placed between ground and the potentiometer slider, whose pointer

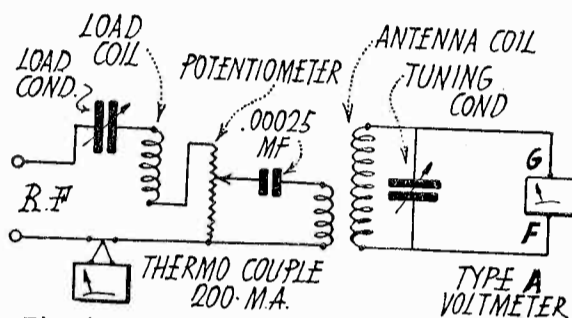

Fig. 6. Set-up for Measurement of Gain in Antenna Coil

with this equipment is the gain of the antenna coil, shown in Fig. 6, the set-up includes a dummy antenna, the antenna coil, a tuning condenser, the tube volt

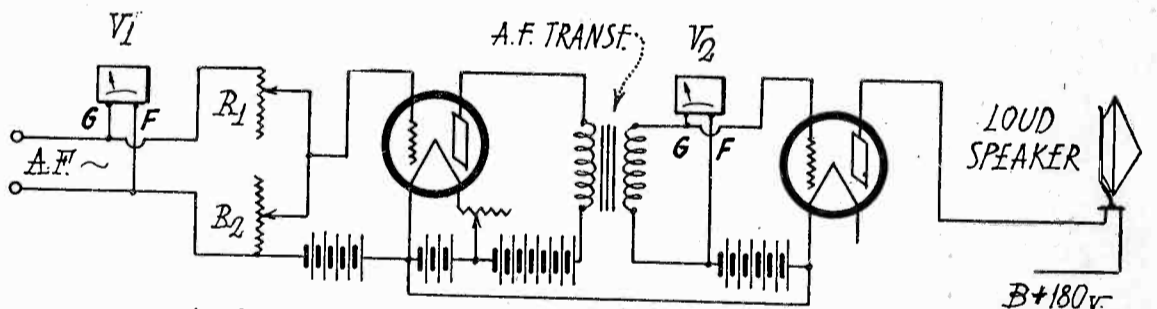

Fig. 8. Set-up for Measurement of Gain in Single R.F. Stage

meter (Type A) and the attenuator. The r.f. source is adjusted to 545 kilocycles and the current brought up to the calibration value as obtained above for this frequency. C is tuned until the tube voltmeter shows a maximum deflection, and the attenuator rotated until the tube voltmeter indicates 1 volt, whereupon the gain is given directly on the scale. Change to another frequency, say 600 kilocycles, and repeat the performance. In this manner the gain of the antenna

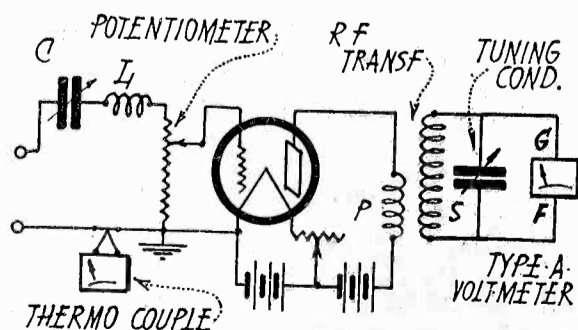

Fig. 7. Set-up for Measurement of Gain in R.F. Stage

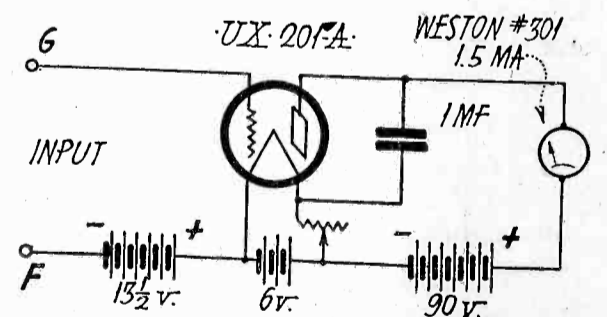

Fig. 9. Circuit Diagram of Small Thermionic Voltmeter for A.F. Work

Audio Frequency Gain

THE principles involved in a.f. gain are identical with those of r.f. gain measurement. The apparatus used is less precise and there is no need of the elaborate shielding that is so essential to good r.f. work. But the same system of a known input and tube voltmeter on the output is used. The essential difference is that we are able to use

(Continued on Page 44)

Harmonic Calibration

Simple Suggestions for Calibrating a Receiver with a Wavemeter and for Making a Variable Audio Frequency Generator

By E. A. TUBBS, ED—7CZ

A HARMONIC is a current or a voltage whose frequency is some exact multiple of some fundamental frequency. Harmonics distort the wave shape of the fundamental. A pure sine-wave contains no harmonics. New frequencies are produced whenever the amplitude of an existing current is changed. If this change is the same for each succeeding cycle, the new frequencies will be exact multiples or harmonics of the original frequency. For example, if a vacuum tube oscillator tuned to generate a wavelength of 600 meters is also generating a wave of 300 meters (the second harmonic); then we may be certain that it is generating a distorted wave form.

The fact that the average oscillating vacuum tube is a prolific source of harmonics becomes very useful when we wish to calibrate a receiving set or a wavemeter. As a good example of this, the writer was asked, in 1925, to design and calibrate a heterodyne wavemeter for government service. This meter was to cover the waveband from 20 to 100 meters. There were then only few short wave stations in operation, and the only one of these that could be relied upon was the American Navy's crystal controlled transmitter on 71.5 meters. By making use of the harmonics of the wavemeter and of the receiver, the wavemeter was completely calibrated from this one signal.

Although the fundamental principle of calibration by harmonics is generally understood, there are a number of difficulties often encountered. While these difficulties prove very annoying at times, they are in reality readily overcome.

An oscillating receiver tuned to 100 meters gives a beat note with a heterodyne wavemeter. For a "zero beat," the two are tuned to the same wavelength (neglecting any autosynchroniz-

ing effects). Likewise a chirp is heard whenever a harmonic of the wavemeter crosses the frequency of the receiver. Thus a beat note is heard when the wave meter is tuned to 200 meters, 300 meters, 400 meters, etc. But as the receiver is also emitting harmonics, a chirp is heard every time any harmonic of the wavemeter crosses any harmonic of the receiver.

Thus if both are emitting up to the fourth harmonic, then we shall get a beat note at 100 meters, when the two fundamentals are together. Next we will hear a chirp at 133.3 meters, when the third harmonic of the receiver is beating against the fourth harmonic of the wavemeter. And again at 150 meters when the receiver's second harmonic is beating with the meter's third harmonic. The next chirp will be heard at 200 meters, when the meter's second harmonic beats with the receiver's fundamental. Also note that at this 200 meter setting, the receiver's second harmonic and the meter's fourth harmonic are also beating together. Increasing our wavelength still higher we will hear chirps at 300 meters and 400 meters. This shows that if we tune the wavemeter far enough to one side of the receiver's fundamental (either above or below the wavelength of the receiver), so that we are working in the region near the limit of harmonics, then the only beats we will hear will be due to a harmonic, of one apparatus, beating with the fundamental of the other apparatus.

Assume that we have forgotten to what wavelength our receiver is tuned, and that the wavemeter will not go below 200 meters. Also let us increase the plate voltage on the detector tube so that the receiver is behaving in a normal manner, and producing a whole string of harmonics. Now on turning the dial of the wavemeter, we find that we hear a

strong beat at 200 meters, then as we proceed upward we will hear several chirps, including a fairly strong one at 250 meters; then at 300 meters we get another strong beat, etc.

At first sight this seems to be some kind of a Chinese puzzle. But let us continue increasing our wavemeter until all the chirps begin to be relatively weak, and here we will note that they are all spaced an even distance from one another. That is we will hear a chirp at 800 meters, then another, slightly weaker, at 900 meters, and still others, gradually decreasing in strength at 1000 meters, 1100 meters, etc. Now you will notice that the difference between any two consecutive beats is 100 meters, and a little thought will show us that this must be the wavelength of our receiver.

Therefore, the rule is that if our wavemeter will not go down to the unknown wavelength of the apparatus, then we take the wavemeter up in wavelength to where the beats begin to grow weak, and then the distance between any two consecutive beats is the wavelength of the fixed apparatus.

Conversely if we desire to find the wavelength of an apparatus, which is above the range of our wavemeter, we will find that the difference in frequency between any two consecutive beats, is the frequency of our "fixed" apparatus. Thus, let us say that we have an oscillating receiver on 300 meters and our wavemeter will only go from 30 meters to 100 meters. Now the chances are that between 100 meters and 75 meters we will hear a number of chirps of varying amplitude, but between, say, 60 meters and 30 meters the chirps, gradually decreasing in amplitude, at 60 meters, 50 meters, 42.9 meters, etc. Now 60 meters is 5,000 k.c., 50 meters is 6,000 k.c., 42.9 meters is 7,000 k.c., etc.; each 1,000 k.c. from its neighbor. Therefore our fixed apparatus must be on 1,000 k.c., which corresponds to a wavelength of 300 meters.

(Continued on Page 34)

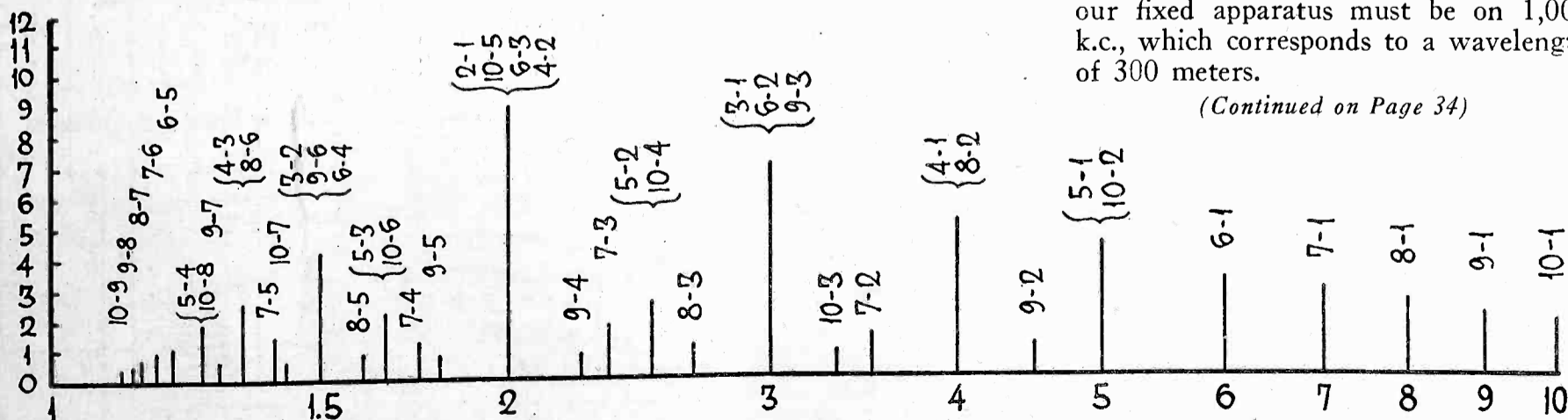

Fig. 1. Relative Position and Strength of Harmonic Beat Note

Additional Data On A. C. Receivers

THE circuit of the Sparton AC-7 receiver, shown on this page, arrived too late for publication in April RADIO. The receiver is a seven-tube tuned r.f. set using all heater type tubes except the power stage, where two type 71 tubes with their grids and plates in parallel are used.

The B supply is furnished by a cold cathode gas type rectifier, which supplies

the cathode of each a.c. tube in the r.f. amplifier, a non-oscillating set is produced. Volume control is obtained by shunting a variable high resistance across the secondary of the first r.f. transformer, and the connection between the resistance and the transformer is made with twisted pair wire.

The three r.f. stages and detector are tuned by a four gang variable condenser, the r.f. coils being of the binocular type, wound with litz wire. Each r.f. stage has a capacity-bridge type of circuit, in which there are two adjustable balanc-

ing condensers to insure freedom from oscillation. Volume control is obtained by inserting a variable high resistance between the cathode connection to the three r.f. tubes, and ground, which is somewhat different from other methods previously described.

In Fig. 2 is shown the circuit of the Fada 7-tube a.c. receiver, together with the power equipment. This receiver has four stages of tuned r.f., with either a loop antenna or outdoor antenna as required to suit local conditions. The r.f. stages are of the neutralized type, and by the use of an elaborate system of shielding, together with other precautions such as r.f. chokes in the leads to

180 volts for the type 71 power tube, and the various intermediate voltages for the r.f., audio and detector tubes. As all tubes in the set except the power tube are of the heater type, only two windings for filament supply are contained in the power transformer.

The new Radiola 105 loud speaker circuit, the first commercial application of the 250 power tube, is shown in Fig. 3. This circuit was designed so that the types 210 and 250 power tubes would be interchangeable, and for this reason, the C bias resistance was made of such a value that it would furnish the correct C bias for either type of tube. A full

(Continued on Page 34)

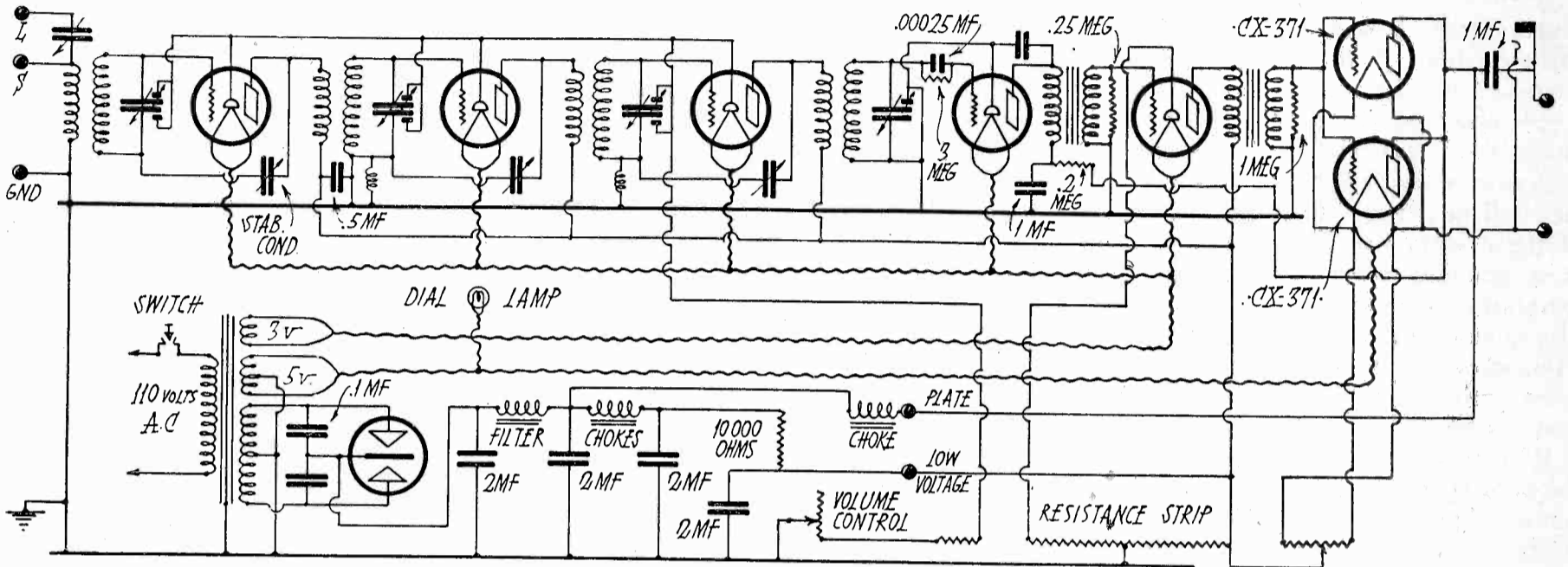

Fig. 1. Circuit diagram of Sparton A.C.-7 Receiver

220 volts d.c. for the power tube circuit, and 90 and 22 volts for the remaining tubes. The voltage is reduced by means of a 10,000 ohm fixed resistor to the value required for the r.f. and first audio tubes, and is further reduced by means of a 200,000 ohm resistor in the B supply lead to the primary of the first audio transformer, so that the detector receives 22 volts.

The filaments of the heater tubes are lighted from a common winding of 3 volts, and the power tube filaments have a separate filament supply of 5 volts. C bias for the various tubes is obtained by means of the voltage drop across a set of resistances placed between the nega-

ing condensers to insure freedom from oscillation. Volume control is obtained by inserting a variable high resistance between the cathode connection to the three r.f. tubes, and ground, which is somewhat different from other methods previously described.

In Fig. 2 is shown the circuit of the Fada 7-tube a.c. receiver, together with the power equipment. This receiver has four stages of tuned r.f., with either a loop antenna or outdoor antenna as required to suit local conditions. The r.f. stages are of the neutralized type, and by the use of an elaborate system of shielding, together with other precautions such as r.f. chokes in the leads to

180 volts for the type 71 power tube, and the various intermediate voltages for the r.f., audio and detector tubes. As all tubes in the set except the power tube are of the heater type, only two windings for filament supply are contained in the power transformer.

The new Radiola 105 loud speaker circuit, the first commercial application of the 250 power tube, is shown in Fig. 3. This circuit was designed so that the types 210 and 250 power tubes would be interchangeable, and for this reason, the C bias resistance was made of such a value that it would furnish the correct C bias for either type of tube. A full

(Continued on Page 34)

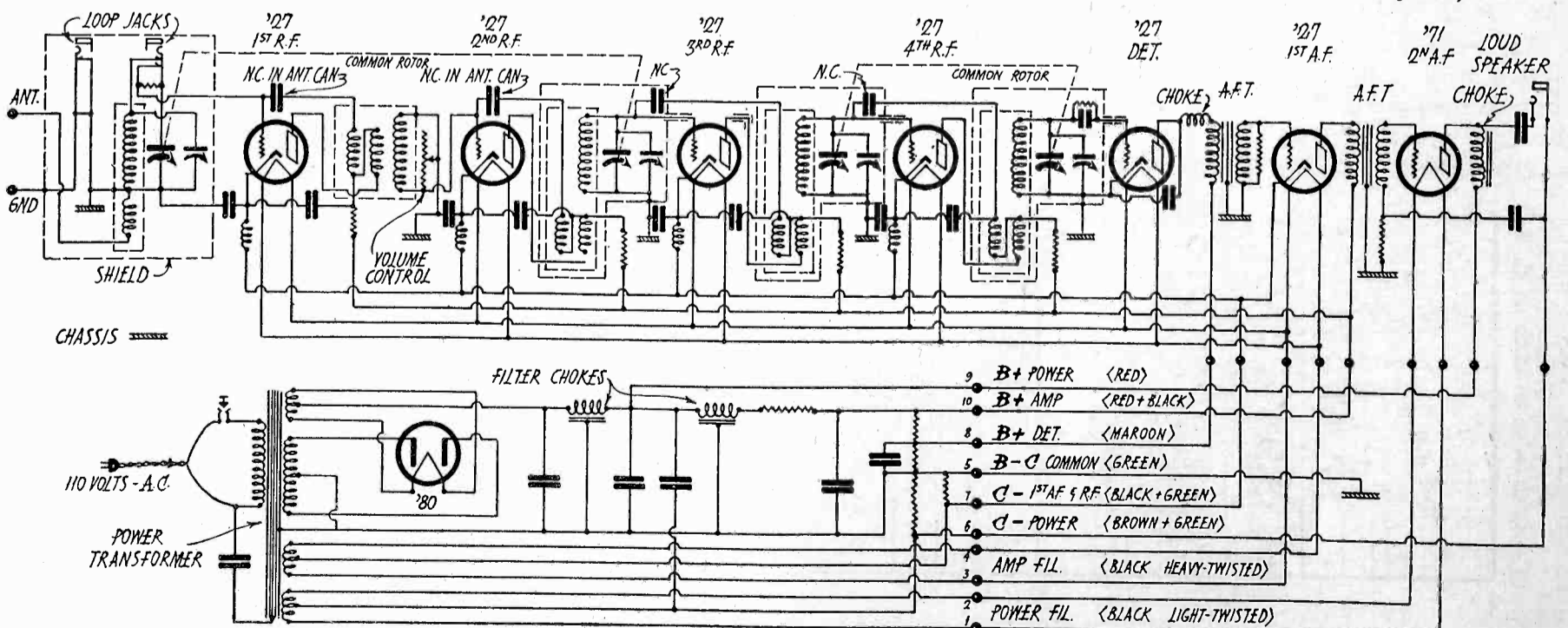

Fig. 2. Circuit diagram for Fada 7-tube A.C. Receivers

Band Pass Filters

By ARTHUR HOBART

THREE methods are available for avoiding the two horns in the dilemma of designing a broadcast receiver which must tune sharply enough to cut out interference and tune broadly enough to prevent distortion of sound. One is to precede the r.f. amplifier with an adjustable band pass filter. One is to couple two resonant circuits with a small inductance or capacity. One is to employ a band pass filter in a super-heterodyne circuit.

The first method, as used by Francis Churchill in his constructional article elsewhere in this issue, requires great amplification in the r.f. stages to compensate for the loss in voltage intensity in the pre-tuning stage. It is especially well adapted for use with the great amplifying power of shield-grid tubes.

The second method, as described by F. K. Vreeland in the I. R. E. Proceedings for March, 1928, loosely couples two series resonant circuits by means of a coil or condenser which is common to both. Thereby their separate resonance curves are merged into a combined curve having a broad top and steep sides, corresponding, for instance to a 10 k.c. band with a sharp cut-off.

In its practical application the coils and condensers ordinarily used for broadcast reception may be coupled with a 1.2 microhenry coil (about 5 turns of No. 24 silk-covered enameled wire on a 1 in. form) or a .025 mfd. condenser. The latter will probably give the better results inasmuch as capacity coupling tends to widen the band at the longer wavelengths and narrow it at the shorter wavelengths, thus compensating for the inherent broadness of tuning on the shorter wavelengths.

This type of filter can be tuned at will to any one of the 10 k. c. channels in the broadcast range of frequencies. What it gains in sharpness of cut-off is somewhat offset by the decreased amplification per stage.

The third method is the band-pass filter whose constants are fixed to pass a 5 k.c. band on either or both sides of a fixed and predetermined frequency such as the i.f. of a superheterodyne. It is one of the filters originally developed by Campbell. To give these constants is the primary purpose of this article.

Fig. 1 shows such a band-pass filter connected between the plate of the last intermediate amplifier tube and the grid terminal of the transformer preceding the detector tube. This filter is seen to consist of a succession of condensers, C_1 connected in series and shunted by three parallel resonant circuits, $C_2 L_2$.

The value of C_1 is chosen so as to pass

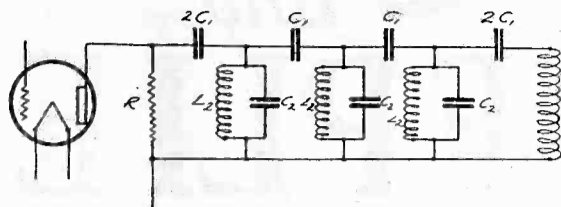

Fig. 1. Circuit Diagram of Band Pass Filter

the desired frequency band and to oppose all other frequencies. The values of C_2 and L_2 in the parallel circuit are selected to oppose the desired frequency and pass the others.

Two limitations must be kept in mind when designing this type of filter: (1) the width of the band which is to be passed and (2) matching the impedance of the filter to the output impedance of the tube which feeds it and to the input impedance of the transformer which the filter feeds. As good quality and selec-

lower frequency f_2 of the band, and the impedance Z of the filter. For a 10 k.c. band f_1 is 5 k.c. greater and f_2 is 5 k.c. less than f .

These constants may be figured from the equations

$$C_1 = \frac{.1592 f}{f_1 f_2 Z} \quad C_2 = \frac{.318 f_1}{f_2 (f_1 - f_2) Z}$$

$$L_2 = \frac{.0796 (f_1 - f_2) Z}{f_1 f_2}$$

Assuming a 10 k.c. band and 10,000 ohms for Z , these reduce to

$$C_1 = \frac{.00001592 f}{f_1 f_2} \quad C_2 = \frac{.00000318 f_1}{f_2}$$

$$L_2 = \frac{7960}{f_1 f_2}$$

Values for the various frequencies used in some of the available i.f. transformers

Values of Constants at Various Intermediate Frequencies for 10 K.C. Band Pass Filter having 10,000 ohms Impedance.

I. F.	30	35	45	52	60	70	80	90	110	115
C_1	.000546	.000465	.000358	.00031	.0002675	.000228	.0002	.000175	.000145	.000137
C_2	.00227	.00238	.00254	.00262	.00268	.00278	.00281	.00285	.0029	.00292
L_2	9.1	6.68	3.98	2.96	2.23	1.63	1.25	0.98	0.66	0.603

tivity may be obtained with a 10 k.c. band, which is the present separation between broadcast stations, this is assumed as the band width in the following calculations. The type of tube determines the impedance, which should be 15,500 ohms for a 199 tube and 10,000 ohms for the A tube. The transformer should be selected for a corresponding primary impedance.

The filter constants also depend upon the peak frequency of the intermediate frequency transformer, with which the band pass filter is to be associated. These frequencies vary from 25 to 350 k.c. for different makes of i.f. transformers, each requiring a different set of constants. Due to the critical effect of a small deviation from calculated values for the higher frequencies, it has not been found practical to design a filter to pass much above 100 k.c.

Examination of the circuit shows that four constants are to be determined: R , C_1 , C_2 , and L_2 . The resistance R across the filter input reduces the B battery voltage to the detector tube. It should have a value of from 10,000 to 20,000 ohms, depending somewhat on the impedance of the tube, which it should approximate. The total impedance Z of the filter should then be about half that of the vacuum tube.

The determining factors in calculating the values of the two capacities and the inductance are the intermediate frequency f for which the transformer is peaked, the upper frequency f_1 and the

are given in microfarads and millihenries in the accompanying table.

Obviously, if a filter is designed for some impedance other than 10,000 ohms, the values of C_1 and C_2 can be obtained by dividing those in the table by 0.6 for 6000 ohms, 0.8 for 8000 ohms, 1.2 for 12,000 ohms, 1.6 for 16,000 ohms, etc. Likewise the values for L_2 can be obtained by multiplying the table values by the corresponding factors. More detailed information regarding these filters was published by Raymond J. Thorpe in RADIO for May and June, 1926. But the essential facts are given in this article.

A practical filter for use between the mixer tube and the first i.f. amplifier tube of the 115 k.c. superheterodyne with shield-grid tubes can be assembled by using as shunt circuits three of the tuned impedances which are used in the i.f. amplifier circuit of the set, mounting the units at right angles to each other so as to minimize the coupling.

The group of series condensers C_1 can be made up from fixed mica condensers which are accurately rated as to capacity. The combination of a .00025 and a .00005 mfd. condenser will give approximately the right value for $2C_1$. For C_1 a .00005 and .0001 mfd. condensers will suffice.

Tests showed that the filter should be terminated with a 10,000 ohm resistance R at its input. If this cuts down the effective plate voltage so that the mixer

(Continued on Page 38)



QUERIES and REPLIES



Questions of general interest are published in this department. Questions should be brief, typewritten, or in ink, written on one side of the paper, and should state whether the answer is to be published or personally acknowledged. Where personal answer is desired, a fee of 25c per question, including diagrams, should be sent. If questions require special work, or diagrams, particularly those of factory-built receivers, an extra charge will be made, and correspondents will be notified of the amount of this charge before answer is made.

Please publish a circuit of a wavemeter such as was shown on Page 29 of September 1927 *Radio*, showing wiring for battery supply instead of a.c.—W. W. B., Zearing, Ia.

A circuit for the combination oscillator and detector, using 6 volt filament supply, and 90 volts of B battery is shown in Fig. 1.

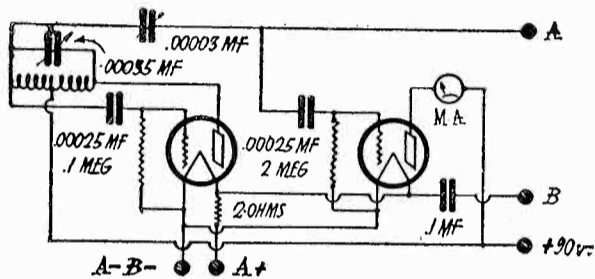

Fig. 1 Vacuum Tube Wavemeter Circuit

No changes are required in the tuning controls, only the battery supply circuits being different from the original layout.

Can you broaden the tuning of a short-wave receiver so as not to be so exceedingly sharp?—O. R. V., Grand Junction, Colo.

In the sense that you can broaden the tuning of a 600 meter receiver, or one designed for broadcast reception, the short wave receiver cannot be treated in the same manner. For short wave phone reception, with a non-oscillating detector, you can undoubtedly broaden the tuning somewhat by using very close coupling between the antenna and secondary circuits, but due to the fact that the average short wave set covers an enormous band of frequencies as compared with the

broadcast receiver, it will still appear sharp in tuning when it is actually quite broad. For short wave telegraph reception, the apparent sharpness will be even worse, unless a small capacity vernier condenser, or vernier dial of high ratio is used.

Would be glad to have an authentic wiring diagram of the Uni-Rectron Model

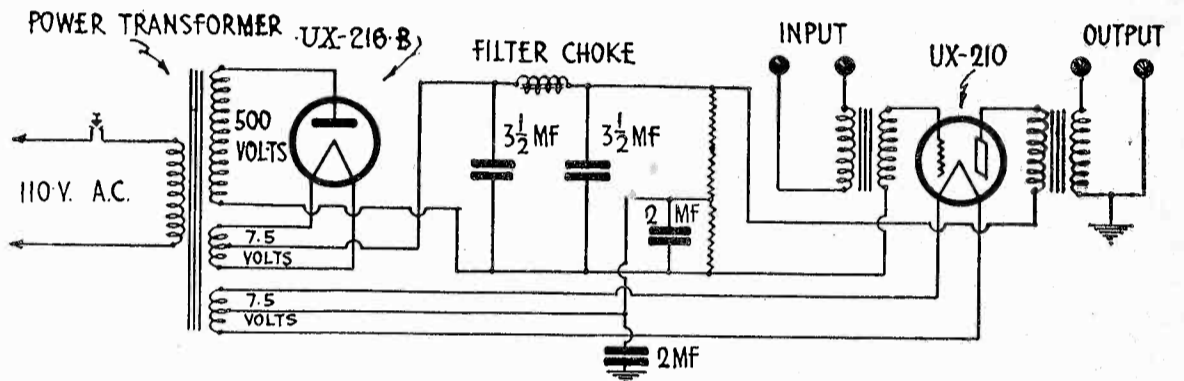

Fig. 2. Diagram of Uni-Rectron Amplifier

AP-535 Power Amplifier.—L. G. G., Bakersfield, California.

The circuit of the Uni-Rectron is shown in Fig. 2. The amplifier consists of a type 210 power tube, supplied from a half-wave rectifier. This outfit formerly used the type 216-B rectifier tube, which has since been replaced by the type 281 rectifier tube.

Would like to adapt my 8 tube Best 45 k.c. superheterodyne to a.c. tubes. Please publish a circuit diagram showing how to change the wiring so as to use a.c. tubes throughout.—R. E. E., Philadelphia, Pa.

A circuit showing the necessary changes is shown in Fig. 3. The oscillator, mixer, detector and first audio tubes are of the heater type, but the three intermediate amplifier tubes are type 26, with the filament operated from 1 1/2 volts a.c. A type 71-A power tube is used, and the C bias for each tube is obtained by means of the voltage

drop across a tapped resistance, between the negative B and the filament or heater connections of the various tubes.

Will 112-A tubes improve the tone of a 5-tube Neutrodyne, when used instead of A tubes in the audio stages? What C voltage should be used?—D. E., Pittsburg, Pa.

You can use 112-A tubes without changes in the wiring or supply voltages, in the first audio stage, but for best results, a C battery of 9 volts and a plate voltage of 135 should be used in the second stage.

(Continued on Page 43)

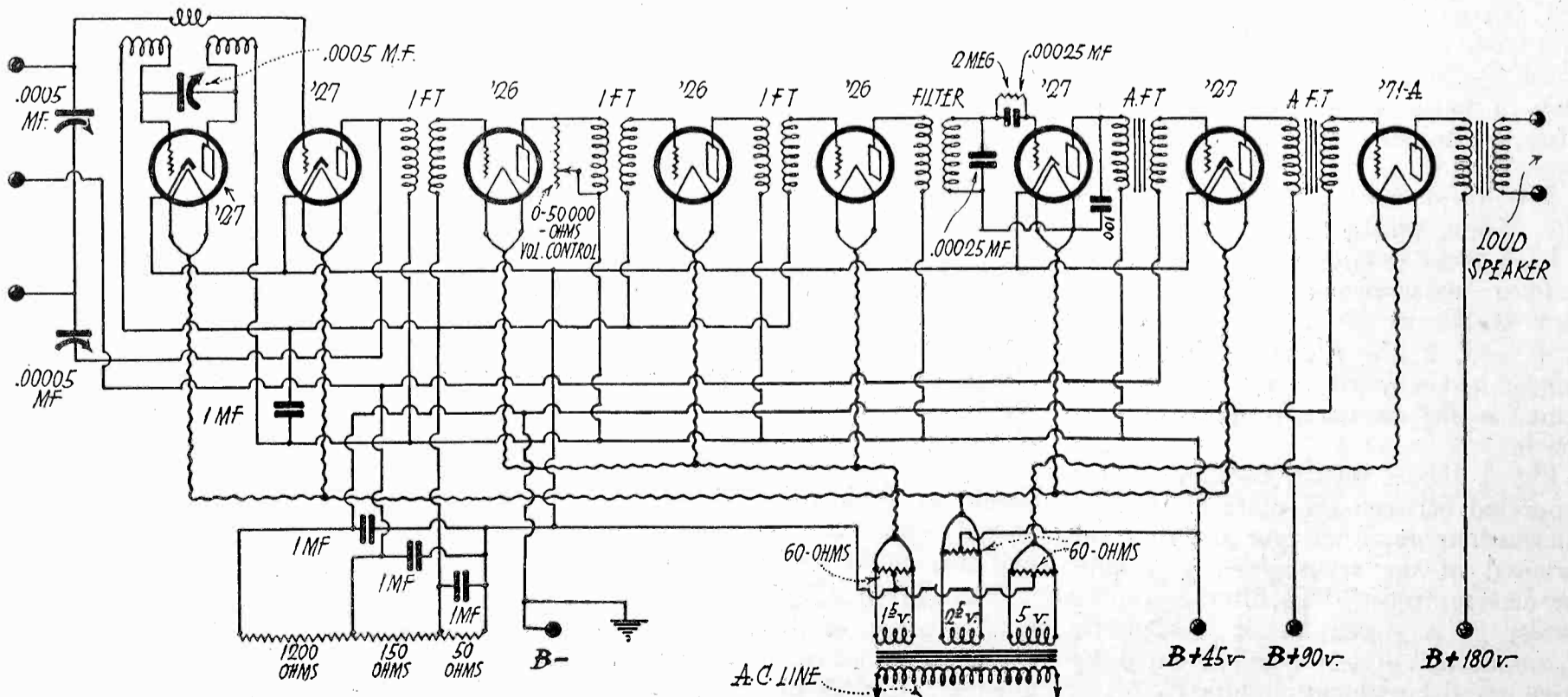
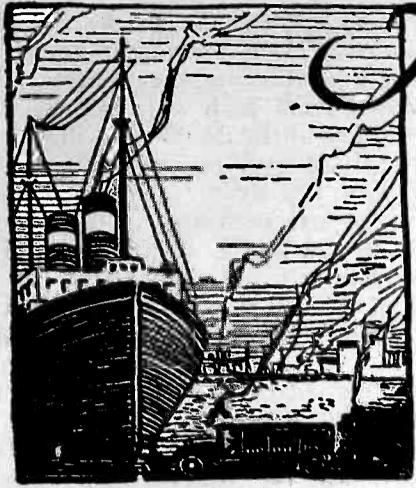

Fig. 3. Circuit diagram of 45 k.c. Superheterodyne with A.C. Tubes



The COMMERCIAL BRASSPOUNDER

A Department
for the Operator
at Sea and Ashore



Edited by P. S. LUCAS
R. O. KOCH, Assistant



WHERE TO?

Great opportunities await the enterprising radio operator. The aviation companies which are springing up everywhere will need operators on planes and at beacon stations. Oil companies, fisheries and mines are beginning to see the need for point-to-point communication. The newspapers are trying to get short-wave allocations for independent service. In all this demand for stations the commercial radio communication companies seem to be overlooking the opportunities for the sale of short-wave sets, leaving to the operator the job of building and installing as well as operating.

With these possibilities ahead, the seagoing brasspounder who wants to get his foot into something ashore might well bait his hook for big fish. Most businesses which might profit from a private point-to-point communication system have yet to be sold on the idea. So it is for the aspiring operator to study their methods of conducting business, determine where money may be saved or made by a private communication system, and then by letter or personal call to prove these facts to the executive in charge.

FISHING TRAWLERS ON THE ATLANTIC COAST

By G. W. TRUDEAU, S. T. Foam

Having sailed on the fishing trawlers of the "KFYY" fleet out of Boston, I think that a brief description of these vessels and the operating conditions thereon may be of interest to other operators who have not had the advantage (?) of this experience. The story of radio equipped steam trawlers properly begins in 1914 when a co-operative scheme was tried. This company operated a large fleet of boats out of Rockland and Portland, Maine, flourished amazingly for a while, and then floundered on the well-known financial rocks.

This brings us down to the latter part of 1923 when four boats operated by the Bay State Fishing Co. of Boston were equipped with 2 kw "P-8" spark sets, and this number was increased to ten before the year was out. In the nature of an experiment at first, it apparently has well paid the company, for they now have their whole fleet of 15 boats radio equipped. There is also a fleet of nine boats operating out of New York by another fish company.

The trawlers are somewhat on the order of large sea-going tugboats, ranging from 120 to 150 feet in length; with a 16 to 26 ft. beam, and carry from 75 to 200 tons of fish. The radio shack is situated in the after-part of the house at the foot of the after-mast; in fact, the mast comes down through it. The crew bunks in the fore peak. The galley is below deck, under the after-part of the house. No eating saloons here; we eat from a plain wooden table in the galley. Not much to these hookers, and conveniences such

as running water, wash basins, mess boys, etc., are conspicuous by their absence. However, what mostly disturbs Ye Op, at times, is the fact that the deck is only about three feet above the water line. I like the sea, but not that well; especially in stormy weather. The four types, or sizes, of vessels differ mainly in their superstructure, and have the radio shacks placed differently. Some being placed amidships just aft the pilot house, a couple of feet above deck, and others are perched atop the after-end of the house, and connected with the deck by a ladder.

But the radio rooms and equipment are all about the same, consisting of a 6x8, or 7x10 foot room containing apparatus and the operators' bunk. The sets were converted from spark last year to the R.C.A. "ET-3226" 1/2 KW ACCW transmitter, and "tin can" tuner with detector and two step amplifier. No auxiliary. Very good work is done considering the QRM which exists around Cape Cod and Nantucket.

The operator's duties are rather more than might be expected as a code is used, and the operator codes and decodes all traffic. Reports are sent to the company's office each morning by all the boats. We are required to copy all company traffic, decode same, and pass it along to the skipper. With ten to fifteen boats at sea all the time it isn't such a cinch to keep track of them all.

It's rather strange to hear the trawlers working sometimes, as the old-timers have the code at their finger tips. We may hear one trawler say "FANZE?" and the answer immediately comes back, "DASIGYPBOL." Which may, or may not, mean anything.

In connection with coding messages, I recall some time ago an operator, not as yet familiar with the code, attempted to say that the vessel's position was Nantucket Shoals, and that they were short of water—but the message as coded expressed it as follows: "What is your position? Nantucket Lightship is out of water. Please advise."

The hours of watch are quite good, being from 6 to 11 a. m., and from 2 to 5 p. m.; all daylight hours. And no press is copied here!

The trawlers generally fish what is known as the Channel, Nantucket Shoal Bank, and Georges Bank; being from 50 to 200 miles offshore most of the time, and, incidentally, stay out until they get a trip of fish regardless of the weather. When a gale comes up they heave to and wait until it blows out.

The fishing is done by towing a huge net behind the vessel as she steams along at about four knots per hour. After an hour or so of towing the net is hauled in and pulled by hand over the side as far as possible, causing the fish to collect in the "cot end" as it is termed.

Then hoisting tackle is attached and it is drawn up until it hangs over the deck; the cot end is untied and the fish fall in a veritable flood—assuming there is enough of them. The catch for a tow may run from 500 pounds to five tons; in the latter case the

whole half of the forward deck will be covered to a depth of a foot or two. The principal kind of fish caught is haddock, with small quantities of cod, pollock, hake, lemon sole, etc.

The skippers are hard bitten old-time fishermen. The deck crew mostly consists of fishermen from Nova Scotia, Newfoundland and Gloucester. One mate is carried. There are two watches, the men working six and six, and tough work it is, especially during a storm in freezing weather when steel cables break, snarl, or get caught in the propeller; nets tear up, and bags of fish burst while being hauled aboard; all to the accompaniment of choice rolling, bucking, plunging, and other capers these vessels are capable of.

However, I may say these trawlers are wonderful sea boats, not one ever having been lost due to the weather; although they are not recommended to anyone even slightly inclined toward seasickness, as their actions during a storm are truly wonderful to behold. A series of motions that are all their own, and may easily cause one's stomach to believe the world has gone mad!

It usually requires from six to nine days to get a trip of fish, seldom longer. Then thirty-six hours in port, and out we come again. To one who has attained the right state of mind, however, there are many interesting and amusing incidents despite the rather acute discomfort at times; and, of course, the wages are rather better than those prevailing on most ships—which "helps a lot."

IN MEMORIAM

It is with mingled regret and pride that we announce the inopportune but heroic passing of one of our fraternity, Leslie J. Hornstra, radio operator of the ill-fated *S. S. Chuky*. Regret, because Leslie Hornstra was taken in the prime of his life, while preparing himself for a very bright future. Pride, because he went down at the key, never for an instant hesitating to put his duty to his shipmates first and his own safety last.

Mr. Hornstra had a great many friends among the brasspounders on both coasts. He was quiet, good natured and a hard worker; one of the old-timers who have consistently put their experience and acquired knowledge into their daily work. He leaves a mother and sister in Los Angeles, to whom the radio fraternity wishes to extend its most heartfelt sympathy.

That QRM and QRN and all the big and little trials and tribulations of a radio operator may be nil in Leslie Hornstra's Haven of Rest is our wish.

"HAMANTICS"

By PAUL OTTO

I write of and to those operators (?) who call a land station many times a day. Sometimes they call every station within their range with that all important "QTC? QRU!" Know the species? If not you must be one of them!

This is good practice for the "first tripper" to overcome his nervousness and key fright, because the answer is always "nil." That is providing the party hasn't been keeping his watch in his bunk!

No doubt it is a soul-satisfying feeling, when you are unconscious for most of the day, to call a land station and shoot him a "QTC? QRU," then drag your poor overworked body back into the bunk to concentrate on an intensive perusal of the latest copy of "True Confessions!"

Why not use that top knot the Lord gave you for the purpose of thinking? Not some, but every coast station sends out the list of calls of ships for which they have traffic on hand. They do this at frequent intervals during day and night. Now wouldn't it facilitate things all around to listen to them calling "roll" instead of starting up that QRM apparatus and asking the foolish question "QTC?" It may sound alright on 20 meters but not on 600.

When you are given an assignment it is taken for granted that you know how to do the work, even if you do not. When you clear for a certain port you should know from where and whom you are likely to receive a message. Your steamship company will hardly send its traffic to you via some "outlandish" station just to accommodate your haming aspirations! They are in business. If there is a station at the port you are bound for they will undoubtedly send their orders through the local office via it. By listening mainly to this station or stations, and at intervals to other stations calling roll, you cannot help but know when there is a message for you and also be able to show by the log that you have been keeping a watch.

I have heard hams calling WSC by the hour around NBA! When they finally raised him, sometimes through another ship station, the reason for all the QRM turned out to be "QTC? QRU!"

This is the species that comes into the static room and holds the embryos awestruck by the hour telling them of the "DX" they worked! They may tell all about "burning up" a coast station, but, horrors, it would never do to tell about "jamming up" one!

Have you ever heard that radio engineer prodigy who calls a station, gives him a TR or message, and then asks "QTC?" This is the same specimen that calls a land station just as he finishes calling roll and inquires "QTC?"

Now this is what I call superb operating, yes, indeed! You certainly have to be intelligent and wide awake to be that good! This genius does not intend to let them slip one into the ice box on him so he kindly informs the operator that now is the time for all good radio operators to hand him his traffic. Then again it may be that starting the set and "QTC?" are so closely related in his cranium, from using the set chiefly for that purpose, that he cannot shut down without sending it! It is surprising what habit will do to you!

Then there is the ham who will call a land station by the hour and finally, after sending it several times QSZ due to local QRM at the land station, get in that all important "TR!" Why in the name of suffering humanity can't they give it to someone who can get it in if it is so important! There are generally one or more ships around that are QSO, either on long wave or six hundred, that will QSR if asked. Some will

even CQ all day long and most of the night for TRs and other traffic to QSR, bless (?) their souls!

Another type of ham that probably has been wished heartily into the nether regions by many an operator is the one that absolutely has to get in that TR or message, or cause other QRM, while the lightship weather is being sent. He cannot wait five minutes longer. Impossible! He might be out of the hop by then and couldn't work!

Last trip I had the pleasure (?) of traveling with several of this species. One of them was one of the "QTC? for him will QSR," "K— de W— QSQ W—," "K— de W— yr TR pse, etc., etc.," hams on the west coast. Near Blunts Reef he called NPW several times (four or five), "NPW NPW NPW de W— W— W— QSQ QSQ NI— NI—," never hearing NPW acknowledge it. This started about the same time WWBU began his weather and continued until after WWBO had finished. Several minutes later this prize operator was CQing for WWBU and WWBO weather!

The next day at noon another of this type had to send his traffic to Seattle during the weather period! It was impossible for him to wait five minutes longer, and when he was through he thought it was real clever! Without a doubt his mother thinks he is!

There are numerous other incidents that could and really should be mentioned, but—

Do a little light thinking. It will pave the way for more serious thought later. That is if you are capable of the ordeal. If not get a place as pantry boy, or some other such job where thinking is not required!

You receive compensation as a radio operator! One of the chief reasons why it is but a pittance for all operators is because some do not use the intelligence, a resultant of common sense, necessary for promoting the profession to higher standards! This may not untie our "Gordian Knot," but most certainly will go far towards loosening it.

NAVAL RESERVISTS AID IN DISASTER

Upon receiving the information that the St. Francis dam had collapsed, flooding the Santa Paula Valley and sweeping away all life and property within its path, two Communications Officers of the United States Naval Reserve, Lieutenants (j. g.) C. S. Pratt and H. D. Watson, put radio station 6YA on the air and immediately established communication with a station in Newhall. This action filled a big gap in the relief work that was being started there, for all commercial communication lines had been carried away by the terrific force of the released water. Much traffic was handled; the sheriff's office was kept in constant contact with its representatives, and many worried relatives and friends were relieved.

Lieutenant Pratt is in charge of the Y. M. C. A. radio school in Los Angeles and is Commanding Officer of the Santa Monica Section of the Naval Reserve District. Until the RCA bought out the Independent, Lieutenant Pratt was I. W. T. inspector for Southern California also. Lieutenant Watson has for many years been chief operator at KOK, as well as night instructor at the "Y." His Naval Reserve duties put him in charge of the Los Angeles Section.

JAPANESE CODES

By JOSEPH N. SMITH

Herewith is a copy of two Japanese codes which I obtained about five years ago, one a Merchant code and the other a Military code. After seeing the Japanese code in the "Commercial Brasspounder," December issue, I thought I would pass them along to other dot and dash men.

My copy does not exactly check with Mr. Doran's code, but I am passing it along "as is." I am not guaranteeing the accuracy, but it was obtained from such a reliable source that I have very little doubt but that it is authentic. In 1922, two of the ops at NPA tried it out on a Jap by coding the Japanese national anthem and sending it to one of the Maru boats on the North Pacific run. How the one who sent it ever managed to get the Jap to keep his foot off the key of his 100 k.w. spark long enough to sit through the session will never be known, but the poor boy took it all in and replied that it was "very good, but spacing bad!"

The "Military" code I know nothing about, but perhaps it will interest someone.

MERCHANT CODE

Cont.	Jap.	Cont.	Jap.
A	I	ND I	GI
AA	NO	NI	DA
AS	WO	NN	NI
AU	WI	NG	RU
AW	TE	NS	NU
AWI	DE	NU	ME
		O	RE
B	HA	OA	SU
BI	BA	OA I	DZU
B UN	PA	OG	GO
		P	TSU
D	HO	PI	DZU
DI	BO		
DM	YU	Q	NE
DN	MO		SHI
D UN	PO		
		R	NA
E	HE	RA I	JA
EI	BE	RN	NG
E UN	PE	S	RA
		T	MU
F	CHI	U	U
FI	DJI	UA	MI
		UI	TO
G	RI	UI I	DO
GA	HI	UN	O
GL	BI		
GN I	JI	V	KU
GM	PA	W	YA
IM	NO	WI	YE
		WN	SE
J	O	WN I	ZE
		X	MA
K	WA	Y	KE
KA	SA	YI	GE
KI	KI	YT	YE
		Z	FU
L	KA	ZI	BU
LI	GA	ZDG	PI
		Z UN	PU
M	YO		
MM	KO		
MN	SO		
MN I	ZO		
	GU		
N	TA		

MILITARY CODE

Cont.	Jap.	Cont.	Jap.
GM	A	Z	GU
L	KA	ZI	BU
LI	GA	ZI I	PU
KA	SA	T	MU
NK I	ZA	NW	YU
N	TA	NG	RU
NI	DA	NO	E
R	NA	Y	KE
B	HA	YI	GE
BI	BA	AG	SE
BI I	PA	WN I	ZE
X	MA	RM	TE
W	YA	RM I	DE
S	RA	O	NE
K	WA	E	HE
A	I	EI	BE
KI	KI	EI I	PE
CE I	EI	DA	ME
OE	SHI	WI	YE
OE I	JI	O	RE
F	CHI	RA	YE
FT	JI	AS	O
C	NI	MM	KO
ZT	HI	MM I	GO
ZT I	BI	MN	SO
GA I I	PI	MN I	ZO
UA	MI	UI	TO
RA	YI	UI I	DO
G	RI	IM	NO
U	U	D	HO
V	KU	DI	BO
VI	GU	DI I	PO
TO	SU	DN	MO
MK I	DZU	M	YO
P	TSU	AA	RO
PI	DZU	J	WO
H	NU		

WHY PRESENT RADIO CONDITIONS

In the following article, Mr. Gillis takes up a rather delicate situation. We hope that if any "Hams" read this they will look at it fairly and try to see the situation as a commercial operator must look at it. Of course, those referred to constitute only a small percentage of the splendid group of amateur operators of which our country boasts; nevertheless, this small percentage can drive the commercial gang back to the pick and shovel if it so chooses. We should consider it a favor, in this connection, to hear from the Hams. Will not someone take it upon himself to defend his clan?

By L. W. GILLIS

What factors are responsible for the present sinking condition of the one-time "rosy radio game?" Are we to blame the operators, the flamboyant insidious advertisements of the radio schools, the influx of the amateur or false public opinion due to the broadcast advent?

As far as I know, no attempt at analysis has been made of the situation by those active in the game; men to whom the profession of commercial operation is a means of livelihood. It seems a paradox to state that he is not interested. Although conditions in both the marine and broadcast are on a down trend, although placement grows more difficult, although wages tread merrily to a shocking low level, no cry of dissent is heard. Why is all this? What factor or factors are responsible?

Nothing rests so heavily on the success or rather lack of success of the commercial game as the "Ham." He is the constant threat, the potential, the wage buster, the radio tourist, the job jammer and the means behind the temporary permit clause of "Section 3, Radio Laws and Regulations, also Section 2." He is the means of insurance in case of jams in the game; in all, he is something no commercial man can love.

To the "Ham," all this may seem new or uncalled for. He can not understand the commercial man's lack of friendship, he cannot understand the "pork and beans" phase of radio. A trip to sea, regardless of wage, places the "Ham" in a heavenly paradise and the chief engineer in hysterics. His talks at the saloon table on short wave work are indeed highly appreciated by a hard-boiled first mate or shell-backed skipper. A short time under the gentle environment of sea-going gentlemen usually suffices to cool the radio glamour for this "Sap Insipid" and he quits. Yes, he quits, leaving a reputation for operators that holds no charm for the relieving man. As new sources of placement for operators open up they are stormed by the "Ham." Such storming is now manifest in the new, point-to-point station work. Most of this work is carried on low wave from approximately 40 to 150 meters. This point-to-point work is used by public utility companies, aviation transport companies, etc.

What has the "Ham" done to this new field; has he attempted to obtain a reasonable wage? Hardly! In fact, the "Ham" is perfectly willing to work gratis or for wages that amount to the same. So intense has the "Ham" stormed this field, that today most jobs in this line are not desirable to the commercial man who must obtain a reasonable compensation for his work. Radio legislation, as far as I can determine, does not compel the employment of a licensed man for this point-to-point work. Under "Amended Regulations Governing the Issuance of Radio Operators Licenses," Radio Convention 1927, thus:

"In special cases where no interference with communications of other stations is involved, consideration will be given to appli-

cations for the operation of particular stations, without technical examination."

What does this section mean other than a funeral passage for the commercial man as far as point-to-point work is concerned? It states directly that no license is required and that point-to-point is destined for a swell butchering by the "Ham." Radio law is full of such jokers.

A source of much pain to the commercial man are the tactics employed by certain schools to attract students. While the advertisements of these certain schools are legally true, they lack an actuality of truth which is appalling to the man who knows. It would seem that men engaged in a work of such a high order as education, the fitting of a man for a vocation, would be more liberal with the truth, or at least more careful with it. I have here before me an advertisement by one of the larger schools. It tells me in flaring gambol of success, romance and world travel. Nice sweet, insidious stuff. It tells me nothing of hard-boiled skippers, of a flooded, jammed field, of the fast dropping wages, of the not-too-easy, not-too-nice sea environments. It tells me nothing of crowded static rooms where hungry, potential operators congregate in quest of a job. It tells me nothing my years of experience have taught!

There is no remedy as far as I can see. Some operators are in favor of the formation of a union or protective association. Let me touch on this subject. I believe that I speak with some authority, for I was actively associated with the old U. R. T. A. and in 1925 I, with others, formed an association at San Francisco. This association failed, not through the bucking of the service companies but due to lack of support by the operators. It is not possible to form an association among men who cannot give any concerted support.

What to do and how, who to blame and why is some question. Perhaps a twenty-one-year-old law would help to eliminate the infants now so numerous. Perhaps some operator could write an article for a newspaper in his home town about the truth of the radio situation. Perhaps an article through the "Ham Magazines" would help and incidentally save some poor ham. But, please do not ask me, I do not know.

SCHEDULES FOR WEATHER BROADCASTS FROM NPG

Effective on and after March 5, 1928, the U. S. Weather Bureau will broadcast weather reports, forecasts, and warnings in International Morse Code from NPG at San Francisco, California. The schedules are in Pacific Standard Time.

(a) 6:15 a. m.—Current weather observations from stations in the United States, Canada, and Alaska. Broadcast simultaneously on frequencies of 4,175 and 8,350 kilocycles. (71.8 and 35.9 meters, respectively.)

(b) 7:30 a. m.—Bulletin containing weather reports, information, forecasts, and storm warnings for the benefit of marine and aviation interests. Broadcast simultaneously on frequencies of 42.8 and 8,350 kilocycles. (7,005 and 35.9 meters, respectively.)

(c) 6:15 p. m.—Current weather observations from stations in the United States, Canada, and Alaska. Broadcast simultaneously on frequencies of 4,175 and 8,350 kilocycles. (71.8 and 35.9 meters, respectively.)

(d) 7:30 p. m.—Bulletin containing weather reports, information, forecasts, and storm warnings for the benefit of marine and aviation interests. Broadcast simultaneously on frequencies of 42.8 and 8,350 kilocycles. (7,005 and 35.9 meters, respectively.)

The 6:15 a. m. (a) and 6:15 p. m. (c) broadcasts are made in the regular U. S. Weather Bureau word code.

(Continued on Page 30)

LETTERS TO THE EDITOR

Sir:

As an ardent reader of RADIO, I wish to offer a little criticism of Mr. Doran's article on Pacific Coast schedules in the April issue.

Mr. Doran has left out of his list, what is in my opinion (and the majority of BPs I've bumped into since it was started), the best press schedule of the Pacific Coast, namely that of KFS, sent to QST at 10 p. m. PST every night on a wavelength of 3050 meters. I have copied pretty near all the American PX skeds at one time or another and have yet to find one that can top KFS. This "FB" is the very latest and it isn't localized like so many of our PX skeds.

Another point, Mr. Doran says that the WNU-WAX skeds are of British character. Now I have copied this PX for the last two years, and in that time I have never noticed such a condition outside of those British items of general interest to the public, but there may be an explanation. Maybe Mr. Doran is on a ship that carries a Chicagoan crew! Hi! Or maybe he's a native son of the windy city. However, WNU-WAX PX has a lot to be commended for. There is nothing local about its character, like the KPH PX, where more than 50 per cent of the items are from San Francisco or vicinity and it is rattled off at a good speed. You don't have to spend an hour to get probably 200 words or so, like some of the PX that is now busting ether.

Guess that's enough out of me for a while. Much luck to the CB and no hard feelings, Mickey, OM.

TKS in advance and 73s,
R. E. H., KFYS.

Sir:

Re the article on QRMers in the Commercial Brasspounder Department of April RADIO, I submit the following from the log of this vessel:

April 3, 1928—12:08 PM WTO de WBA (Jamming WWBO'S qst).

April 10, 1928—12:03 PM KPE de KLIU qtc? nil.

While on the subject of QRM during lightship weather broadcasts would like to suggest that the coast stations QRT during the ten minutes in which lightship weather is supposed to be sent. It is a common thing to hear some ship call a coast station during a broadcast and to hear the coast station come right back and tell him to go ahead. From KSE to VAE and KPE they are all guilty of this practice. The coast stations can eliminate a lot of this QRM by refusing to work ships on 600 during the ten minute weather periods. Ships working KSE and KOK can and do cause QRM to WWBO and WWBQ besides lightships farther south.

By all means let's have the honor roll of QRMers.

WM. J. HUSSEY, Opr. WPBP.

Impedance Relations

Sir,—

I read with some interest an article in the May 1928 issue of RADIO by Nelson P. Case. This is the type of discussion I should like to see appearing oftener in the pages of American radio magazines. The simplest possible mathematical treatment of a question, followed by an interpretation of the results so that they may be put into actual practice, would seem a good rule. Any possible experimental verification, too, should be included. Perhaps a little greater respect on the part of radio writers for simple, well known physical laws governing the performance of all electrical apparatus and circuits would serve to clear up a few of the loose and often entirely incorrect statements that

(Continued on Page 40)

With the Amateur Operators

AN AMATEUR TRANSMITTING ANTENNA FOR ALL BANDS

By L. W. VAN SLYCK—9EMB

The Government authorizes any licensed amateur station to use bands in the vicinity of 3/4, 5, 20, 40, 80, and 160, meters for transmitting purposes. Most stations actually use only one or two of these bands, and those who use more usually have several antennas to accomplish it, or obtain poor results on one or more bands using a hit and miss installation.

There is nothing new about the use of a transmitting antenna working on a harmonic, but from the information the writer has been able to collect, the construction of such an antenna is usually rather a hit or miss affair in the average amateur installation. An antenna is described here which will give good efficiency on 20, 40 and 80

as a full wave antenna, or on its second harmonic. The current distribution in this case is shown by curve Y. Also, by coupling a transmitter tuned to 20 meters at a point 1/8 of the distance from one end, the antenna would oscillate on its fourth harmonic, but, of course, would radiate on 20 meters. Curve Z shows the current distribution.

It is obviously not practical to have coupling coils at all these places, coupling to various coils for various wavelengths. So the next best thing is a compromise. By referring to the curves of Fig. 1, which are drawn to scale, and searching for the "compromise point," it will be readily located at approximately 40 ft. from one end, and hence 80 ft. from the other end. This means that we must take 120 ft. of wire for our antenna, cut it so that we have one piece 40 ft. long and the other 80 ft. long, and put them up in the air, bringing one end of each to a

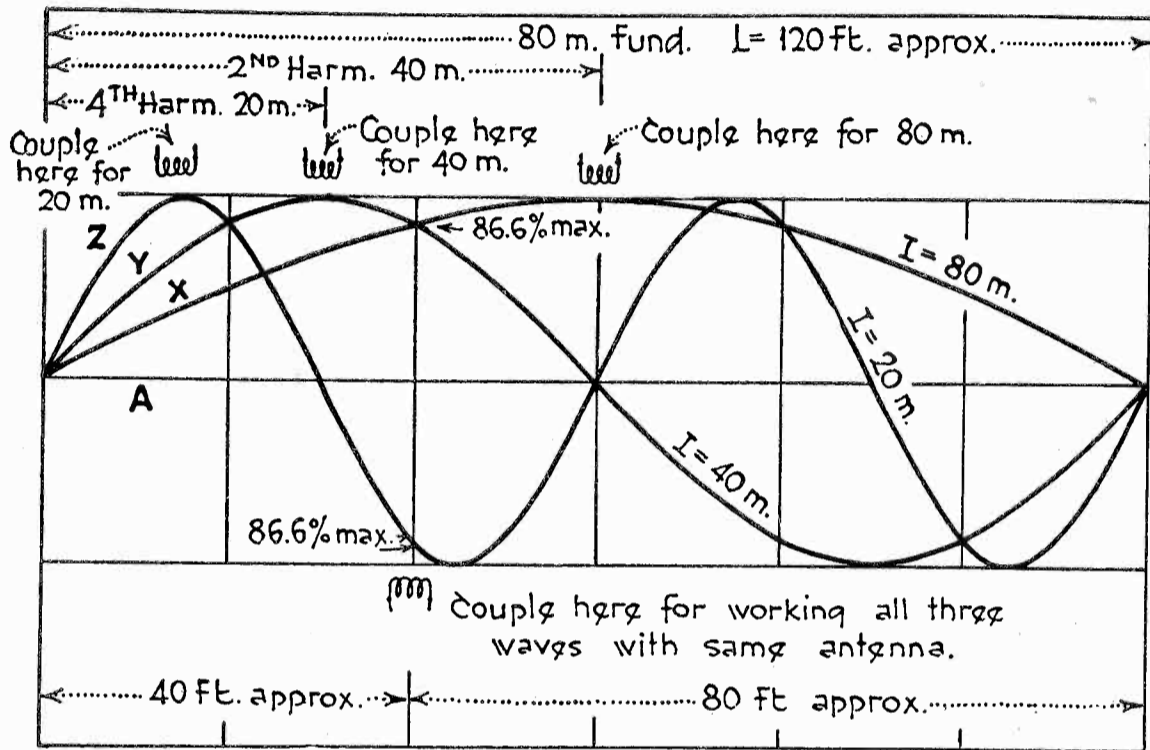

Fig. 1. Antenna Current Distribution Curves for Various Wavelengths

meters, having been actually installed and tested on these three bands. There is no doubt but what it will work as well on the 10 meter band, which will be ours next January. With slight changes it can be adapted for 160 meter operation.

Referring to Fig. 1, A represents a wire approximately 120 ft. long. If this were coupled to a transmitter tuned to 80 meters by use of a coupling coil and series variable condenser inserted at its center, it would be possible to obtain resonance, and the antenna would be worked as a half wave antenna, or in other words, it would radiate on its fundamental. Curve X shows the current distribution in such an antenna working as described. This would be the best way to work for 80 meter operation only.

By coupling a transmitter tuned to 40 meters at a point one-quarter of the distance from one end, the antenna would operate

coupling coil and variable tuning condenser, coupled to our transmitter.

Fig. 2 shows an ideal construction for such an antenna-counterpoise system. This layout may be changed to fit local conditions, as long as the two wire lengths are not materially changed. It is obviously desirable to get the longer wire up in the air higher than the shorter. Incidentally, this also is feasible because if the proportion of lengths of the two wires is to remain somewhere near where it is calculated, this is desirable, in order to equalize as nearly as possible the capacity to ground of the two wires.

By referring again to Fig. 1, we see that the actual antenna current should be somewhere 86.6 per cent of possible current when working an antenna on its fundamental and tapped at the center. This figure looks beautiful on the drawing, but don't take it to

(Continued on Page 43)

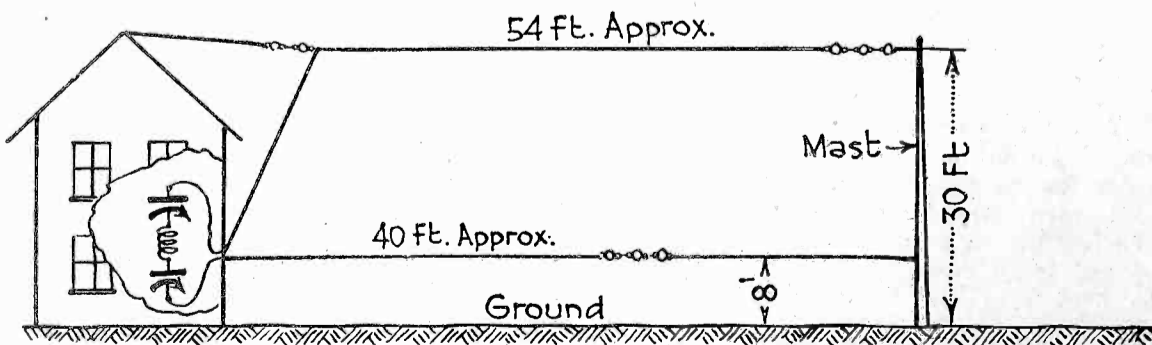

Fig. 2. Antenna-Counterpoise Construction

CALLS HEARD

By 2ASB, Frank R. Day, 3212 Farragut Road, Brooklyn, New York

6aau, 6adw, 6agg, 6ahn, 6aij, 6aks, 6am, 6amn, 6ano, 6atk, 6axu, 6bil, 6blu, 6bmw, 6brc, 6buh, 6bvf, 6bwi, 6bxd, 6bzn, 6cbp, 6cct, 6cgr, 6cis, 6cjb, 6cqa, 6cto, 6cua, 6cvj, 6cwf, 6cyr, 6czc, 6czo, 6dbm, 6dhu, 6dlj, 6dlj, 6dmp, 6dmq, 6dmw, 6dnn, 6dpa, 6dtc, 6dtp, 6dxb, 6ec, 6eu, 6fh, 6ih, 6jp, 6sj, 7adb, 7afz, 7agn, 7aik, 7ail, 7bm, 7dd, 7dl, 7ei, 7fe, 7fu, 7jc, 7qg, 7tz, 7uo, 7yg.

eaKL, eaSPO, eb4au, eb4av, eb4cb, eb4ck, eb4dk, eb4dj, eclfm, ed7fr, eeEAR24, eeEAR65, ef8abc, ef8btr, ef8cd, ef8dmf, ef8er, ef8fd, ef8fdm, ef8la, ef8orm, ef8prsv, ef8vvd, ef8ycc, eg2ao, eg2dd, eg2hk, eg2nh, eg2sc, eg5bd, eg5by, eg5dh, eg5ml, eg5mq, eg5sw, eg5uw, eg5wq, eg5yx, eg6ia, eg6rw, eg6uh, eilcm, eiler, eilmg, eilno, eilrn, ek4ue, ek4uf, en-zero-FY, en-zero-WIM, ep3am, foA3Z, fqPM, nclap, nclax, nclbr, nclda, nc4cb, nc4gi, nc4ha, nc5by, nc5cj, ne8ae, nbBE3, nm1ng, nm9a, nq2ac, nq2cf, nq2jt, nq2la, nr2fg, oa2dy, oa2mh, oa2rc, oa2xi, oa3au, oa3ca, oa3cp, oa3jk, oa3ls, oa3wm, oa3yx, oa4aw, oa5cg, oa5fb, oa5mb, oa5wh, oa7cw, oh6dju, oz1fb, oz1fe, oz2bf, oz3az, oz4aa, oz4am, sb1bg, sb1ck, sb2ax, sb2ss, WMP.

All heard on 40 meters.

By G6PP, 54 Purley Avenue, London, N. W. 2, England.

1afz, 1age, 1ajd, 1bmg, 1bnm, 1cx, 1ex, 1kk, 1my, 1rf, 1rn, 1tr, 2ach, 2anq, 2atx, 2baz, 2bxr, 2czr, 2hc, 2wq, 3aim, 3anb, 3ani, 3bph, 3dew, 3ex, 3le, 3vf, 3wm, 4acn, 4act, 4acz, 4adg, 4bb, 4ei, 4ie, 4oh, 4oo, 4ow, 4rk, 4si, 4sx, 5afx, 5kg, 5oa, 5yw, 8baq, 8bbs, 8bcq, 8bhi, 8bhq, 8bqm, 8cgl, 8don, 8dpo, 9aey, 9cvn, 9bmm, 9dyt, 9eag, 9eaj, 9efo, 9wu, oa6ag, odpkl. pse qsl if u hr mi 45 mtr dc sigs.

S. S. Samuel Q. Brown, KVDO, Amuay, Venezuela
20 Meters

1BEB, 1ZZ, NC-1AW, 1AHY, 1ATR, 1SZ, 1HV, 2BGC, 2CK, 2GP, 2VI, 2BBX, 3AKW, 3JM, 4NL, 4EC, 4ADB, 5AR, 5LP, 5MX, 6AVI, 6DCV, 6DG, 6AAT, 6CSR, 6ARY, 6BJF, 6INY, 6CXO, 7VZ, 7FE, 8DBE, 8DZM, 8CFR, 8AUB, 8RE, *9DBJ, 9DBJ*, 9AJW, 9HM, 9DPB, 9EHM, 9CVU, 9CUG, 9DPW, 9AS, 9ELN, 9ANZ, NM 9A.

40 Meters

1LX, 1AM, 1BCB, 1AQP, 1AGW Su-1FC, 2QU, 2XS Phone, NR-2AGS, 2BEW, 2AED, 2BDA, 2AVG, 2CDM, 2WW, 2AFA, 2CCD, 2HV, 2GP, 2AUA, Sb-2AR, 2BIP, 2OT, 2AN, 2ABY, 2ACH, 2FG, Nc-2BE, 2BAY, 2FG, 2AGW, NR-2AGS, 2BCW, 3CC, 3SZ, 3ALI, 3ANH, 3AVK, 3ANF, 3UA, 3BIU, 4HX, 4AAR, 4KY, 4DO, 4OX, 4OZ, 4EQ, 4DT, 4RP, 4HX, 5RG, 5LA, 5ACL, 5AEB, 5AWO, 5FB, 5WE, 5MX, 5AYO, 5ADV, 5TA, 5APM, 5AEJ, 5HY, 6BRO, 6HK, 6CBD, 6BSC, 6BPM, 6AHP, 6NW, 6QF, 6AFS, 6DOG, 6EC, 6AHP, 6ADB, 6INY, 6CZO, 6BPO, 6EB, 6BCH, 6AM, 6DWF, 6EC, 6BAM, 6BIU, 6BEJ, OH-6XK, 6HM, 6HM, 6DWF, 6AAU, 6BJL, 6AD, 6DSU, 7FF, 8CBF, 8AXZ, 8AIC, 8DMZ, 8CC, 8JB, 8AIG, 8WO, 8DFW, 8GL, 8AHU, 8BJX, 9CZW, 9AXX, 9AOK, 9EFZ, 9EWL, 9ELL, 9DUX, 9BNB, 9DKC, 9BOC, 9BEC, 9BBW, 9CHS, 9CVU, 9DCB, 9CSM, 9AYX, 9BPN, 9HI, 9BAD, 9CUO, 9CWA, 9CFT.

80 Meters

1IN, 1BBJ, 1FL, 1AIT, 1XV, 1AEF, 1AFB, 1ANH, 1ASD, 2BIC, 2BIF, 2DV, 2CPG, 2BCP, 2JX, 2AOO, 2CP, 2SB, 2AAT, 2MT, 2XG, 2BSC, 2SC, 2EV, 2BEX, 2CVH, 2CXL, 2ALO, 2BHL, 2CBP, 2CPD, 3DEW, 3UZ, 3JH, 3XS, 3AS, 3AEI, 3CJW, 3AQI, 3ZF, 3ALE, 3ADM, 3ZI, 4CS, 4LU, 4FX, 4BL, 4FF, 4SP, 4CN, 5QA, 5AQD, 6AOD, 6DON, 8BYN, 8DYK, 8DTC, 8HVY, 8BUH, 8JB, 8MQ, 8PJ, 8CZW, 8ANO, 8DAQ, 8CSW, 8BNF, 8DON, 9DDS, 9AAF, 9CUO, 9EDO.

The above stations were copied in Amuay Venezuela while in port from January 16 to 21, 1928.

NPG SCHEDULES

(Continued from Page 29)

The 7:30 a. m. (b) and 7:30 p. m. (d) broadcasts are the regular marine and aviation bulletins heretofore broadcast at 9 a. m. and 7:30 p. m.

Weather reports from ships in the North Pacific Ocean will follow the reports from land stations as heretofore, but 4 a. m. (120th meridian time) reports hereafter will be broadcast in the 7:30 a. m. bulletin of the same day, and the 4 p. m. (120th meridian time) reports in the 7:30 p. m. bulletin of the same day.

A 50-WATT PORTABLE TRANSMITTER

By D. B. McGOWN

The Hartley oscillator here described was designed for portable use and consequently employs the Hartley circuit because of its ease of adjustment, when used with various antennas. The closed circuit, comprising L_3 and C_2 , may be tuned to the proper wavelength range when the set is built, C_2 being

condensers. The antenna loading inductance L_1 is composed of 7 turns of 3/16 in. copper tubing, wound as a helix, L_3 has 9 turns and L_2 3 turns of the same tubing, L_2 being 2 in. from the plate end of L_3 . The copper turns were supported in half-round slots in 1/2 in. maple boiled in paraffine. This part of the circuit is designed to cover from 32 to 44 meters.

C_3 and C_4 have a capacity of about .0002 mfd. and are made by separating three 1 by 1 1/2 in. strips of copper foil with double

strength mica, all being clamped between bakelite blocks and boiled and cooled in paraffine and beeswax so that the condenser is sealed from moisture. C_5 and C_6 are sealed mica condensers of .001 mfd. capacity.

The power transformer was made up on a silicon steel core 1 1/2 in. high and 4 by 5 in. outside dimensions with a 1 by 2 in. window, using strips 1 1/2 by 2 1/2 in. and 1 1/2 by 3 1/2 in., respectively. The primary consisted of 500 turns of No. 20 DCC wire, divided into two coils, 250 turns being wound on each of the longer legs of the core. The secondary consisted of 2500 turns of No. 28 enameled wire, wound in layers, over the primary, and separated from the latter by three layers of empire cloth. Adding machine paper strip, dipped in paraffine was used between layers. This gives about 1100 volts secondary. For the 852 tube, the secondary should have 5000 turns per coil of No. 32 wire.

The filament transformer was wound on a core 1 in. square section and 3 by 4 in. outside size, with a 1 by 2 in. window. The primary was made of 770 turns of No. 24 DCC wire, 385 turns per leg, wound over the secondary. The latter consisted of 86 total turns (43 per leg) of No. 16 DCC wire, the mid-tap being taken off where the two coils join. This gives slightly higher than 11 volts secondary, but this is taken care of by the manipulation of the 10 ohm rheostat in series with the primary.

The radio frequency chokes were composed of 200 turns No. 30 DSC wire wound on a 1 in. hard rubber tube. These are connected in series with the plate supply, as shown.

The only two meters provided are the an-

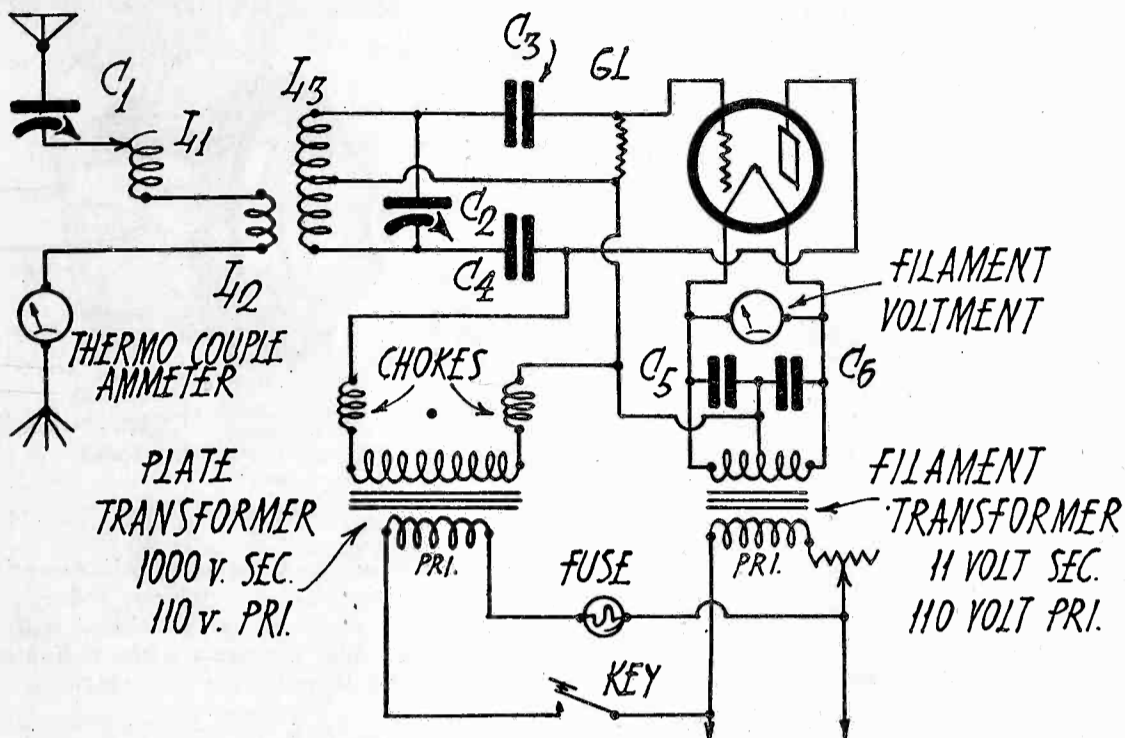

Circuit Diagram of 50-watt Portable Transmitter

calibrated directly in frequencies or wavelengths. The antenna circuit, with its variable controls, may quickly be tuned to resonance with any antenna after fixing the coupling between the closed circuit and L_2 . The set uses either a 50 or 75 watt tube.

For operation, there are but two adjustments after the equipment is set up. The righthand dial is first adjusted to the desired wavelength. Then, with the key closed, the lefthand dial is adjusted until the antenna ammeter indicates resonance. If the coupling is too close, increase the antenna inductance and decrease the antenna capacity. The converse also holds true.

The set is operated from 110 volt, 60 cycle, socket power through two transformers mounted in the lid of the carrying case where the hand key is also located. Flexible cords with plugs lead to the jacks in the transmitter panel.

The variable air condensers C_1 and C_2 have a capacity of .00012 mfd. secured by removing alternate plates from .0005 mfd.

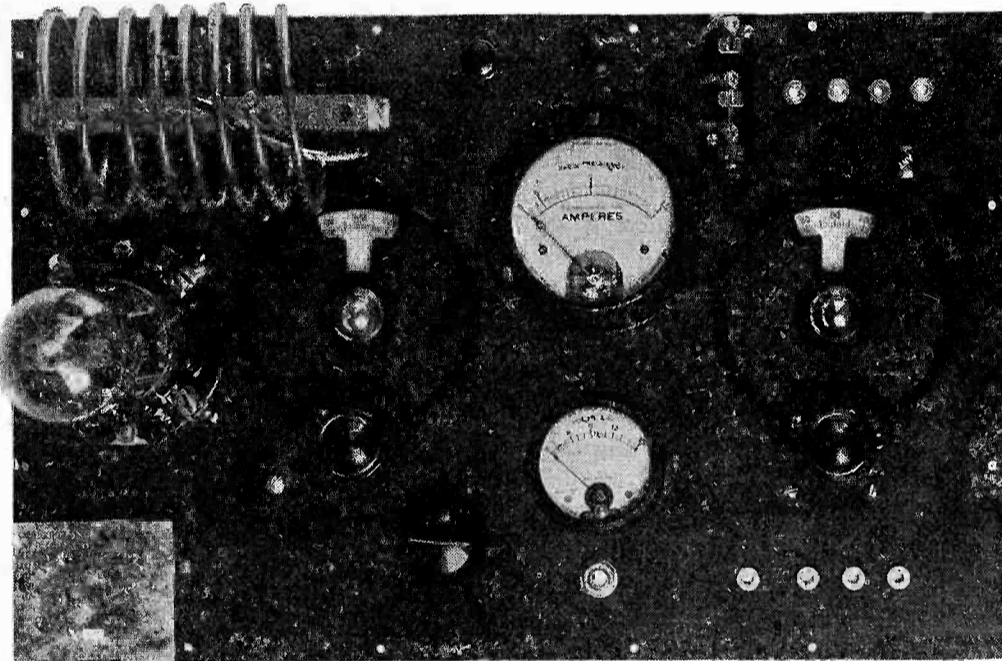

Panel View of 50-watt Transmitter

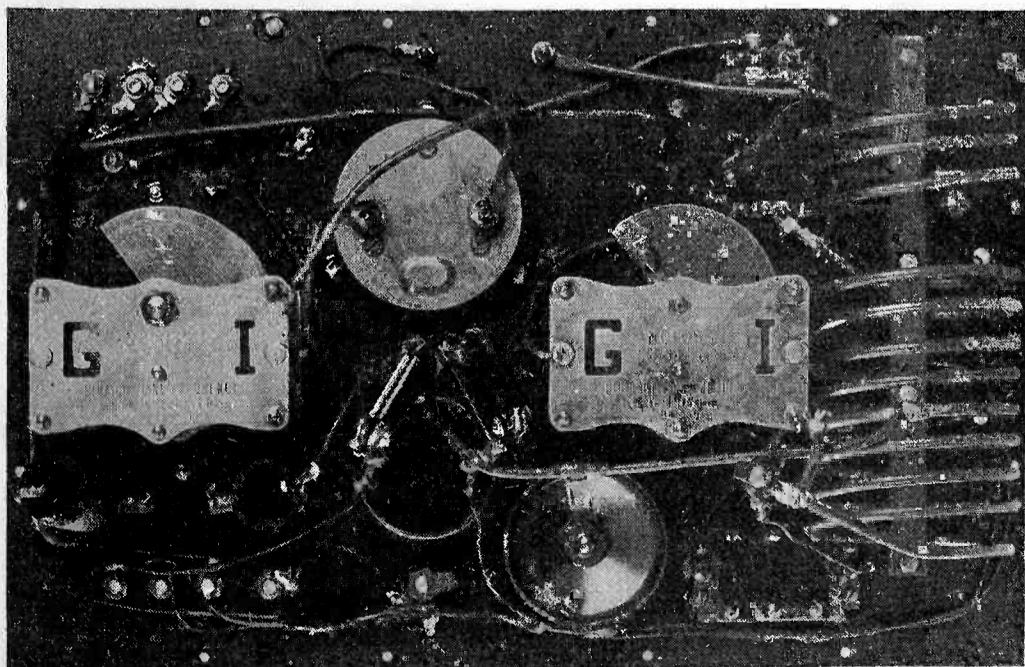

Rear of Panel for 50-watt Transmitter

tenna ammeter, which is an 0-1.5 thermo-couple instrument, and an 0-15 volt AC voltmeter. In tuning for the first time, a milliammeter should be connected in the plate circuit, in order that the tubes may be operated without abuse. It would be advantageous, although not essential, to place fuse in the primary circuit, as indicated at F. This may be a simple link of 1 amp capacity fuse wire, screwed under knurled nuts. This will blow immediately if any trouble is present, thus saving the tube and equipment; wire of this capacity will blow out in service every now and then, but this is not a serious defect.

A small double throw single pole switch was mounted on the panel to provide for change-over from transmitting to receiving. This may, of course, be of any convenient type.

The range of such a set as has been described is problematical, but it should be capable of carrying on communication over several thousand miles under favorable conditions, with a skilled operator in charge.

Radio Kit Reviews

RADIO U-2XE

By W. A. SCHUDT, JR.

Radio U-2XE, owned by A. H. Grebe Company at Richmond Hill, N. Y., and constructed by Wm. Schick, a Grebe engineer, broadcasts WABC programs on 58.5 meters. It is designed with quartz crystal control to have constant wavelength notwithstanding swinging of the antenna or changes in plate or filament voltage. The natural period of the crystal is 117.1 meters.

on the operator's desk, 20 ft. distant. This wavemeter is tuned to resonance with the transmitter and indicates its proper functioning.

A. C. filament current is supplied through transformers with controlling resistances in the primary and center-tapped secondaries to eliminate a.c. hum and center-tapped condensers to keep r.f. current out of the filaments.

The 127 Arcturus a.c. tube is of the 2½ volt heater type with a guaranteed life of

The Wirt a.c. voltage regulator is a useful accessory to a receiver using a.c. filament vacuum tubes. It is plugged into the socket supply and is connected to the high-

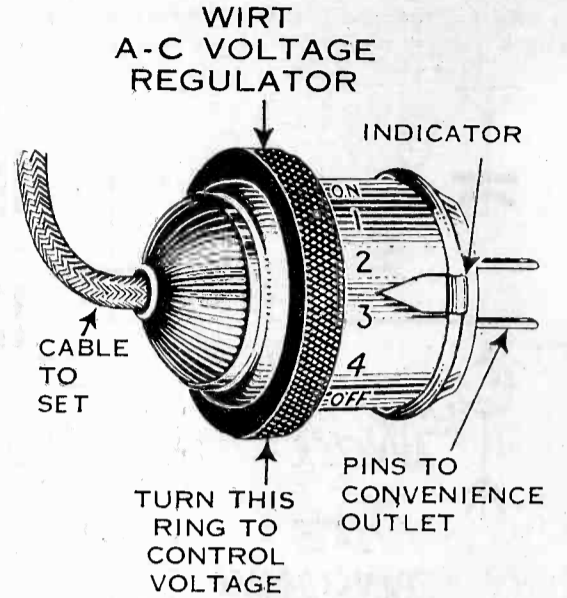

voltage terminals of the set. It is essentially a heavy duty rheostat which reduces the supply voltage to a value which will not burn out the tube filaments after it has been stepped down through the transformer.

The Electrad Truvolt is a variable resistor intended for use as a voltage divider in a battery eliminator. It is provided with one or more sliding taps which make positive metallic contact with a Nichrome wire resistance unit. This unit is ingeniously wound so as to be exceedingly compact and to have a large surface for dissipating heat. Truvolts are made in various sizes having maximum resistance values of from 500 to 50,000 ohms and having capacities of 25, 50 or 75 watts. They are designed so that the resistance of each effective turn is equal to the total resistance of the unit divided by the number of turns, the 25 watt units having 30 turns, the 50 watt, 66 turns, and the 75 watt, 98 effective turns. Their use does away with the troublesome calculations and measurements necessary with the usual fixed resistances and al-

(Continued on Page 42)

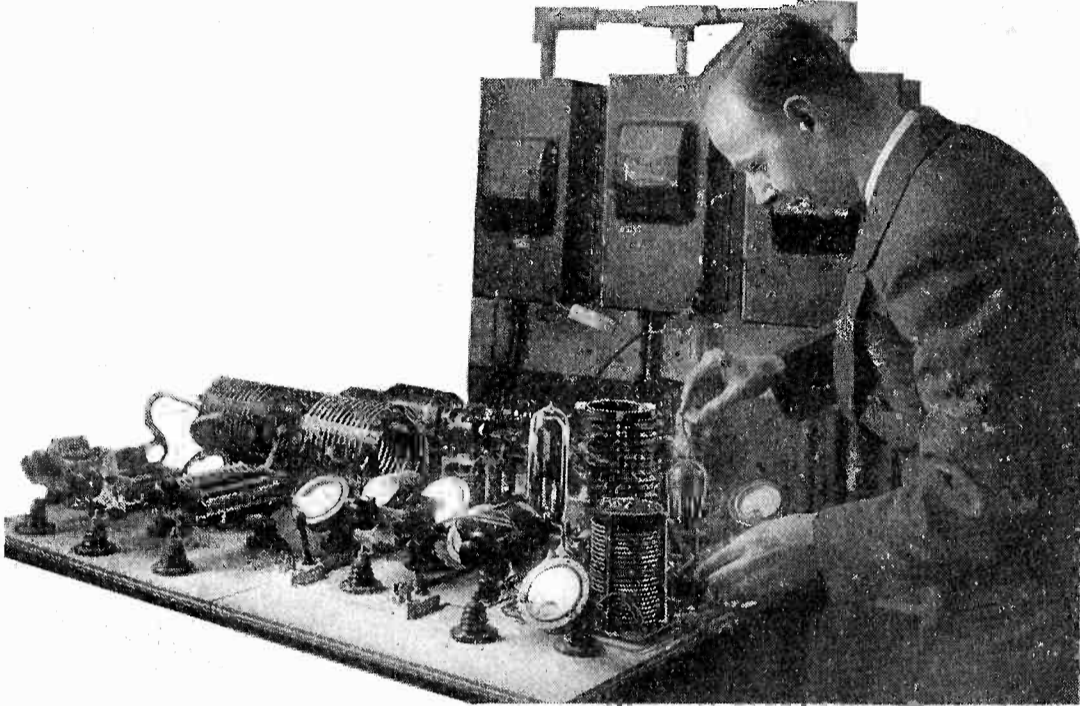

Short Wave Transmitter at 2XE

The oscillator is a 7½ watt tube whose plate is supplied with 40 m.a. at 280 volts. Its output is first amplified and its frequency is doubled by a 50-watt tube with 1000 volts on its plate. The final amplifier is a 250-watt tube with 1700 volts on the plate, being neutralized to prevent regeneration. The antenna is 29.6 meters long.

A small coil near the last amplifier picks up energy which is fed through a loosely coupled wavemeter and galvanometer

1000 hours and attaining full heat in from 6 to 15 seconds after the current is turned on. Its normal operating voltage is 2.25, with a tolerance of 25 per cent variation due to changes in line voltage. These results are due to a number of changes in construction, including a reduction of the space between the cathode and heater, the use of a cathode having rapid heat-absorbing properties, and the use of a special insulating coating on the heater.

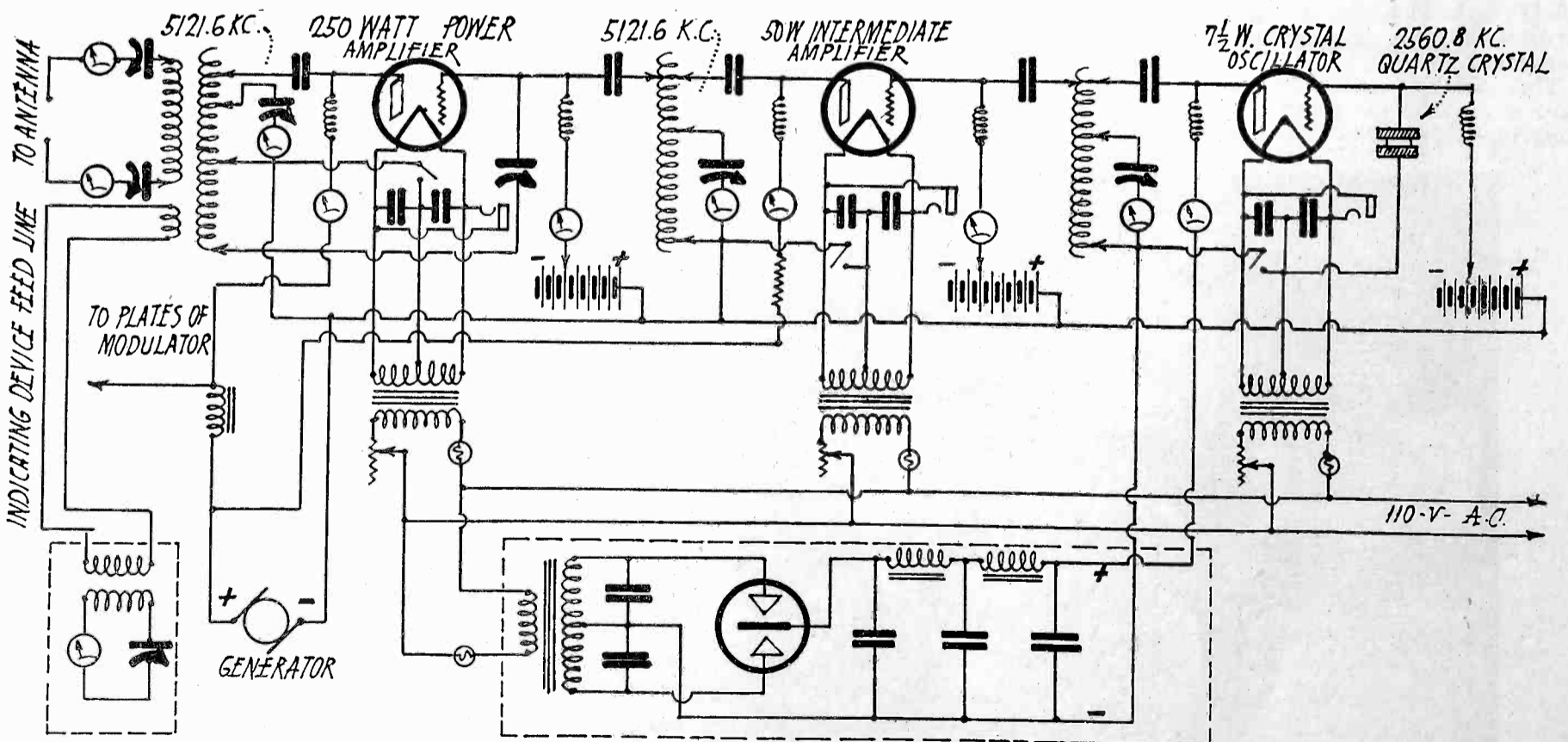

Circuit Diagram of Short Wave Transmitter at 2XE

No Acoustic Limitations

In every radio receiving circuit there is a definite point where the audio-frequency current is transformed into actual sound. This was the major limitation on satisfactory reception—until the Jensen Dynamic Speaker came to the rescue. Now, no receiver need be handicapped

by the acoustic limits of the speaker that gives it voice. Now, you can be sure that your set is performing at its maximum capacity, and with utmost fidelity. Regardless of price or make, we believe you will agree with us that the Jensen Dynamic Speaker is the "finest in radio."

JENSEN DYNAMIC SPEAKER

"The finest in Radio"



Console Model

To the Professional Set-Builder

Your reputation depends on the performance of every set you build and sell. Your customers are comparing your work with the receivers made by America's largest factories. Every time you win by actual comparison, you have won a new customer.

Now—with Jensen Dynamic Units—you can give them tone-clarity such as they have never heard before. Now you can welcome any and every test of tone-quality. The Jensen Dynamic Speaker puts you ahead of competition.

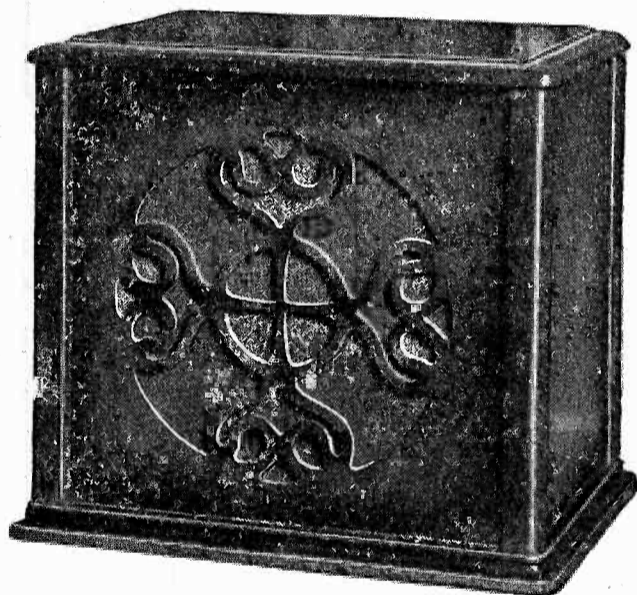

Cabinet Model
TYPES D-44, D-45, D-44 A.C.

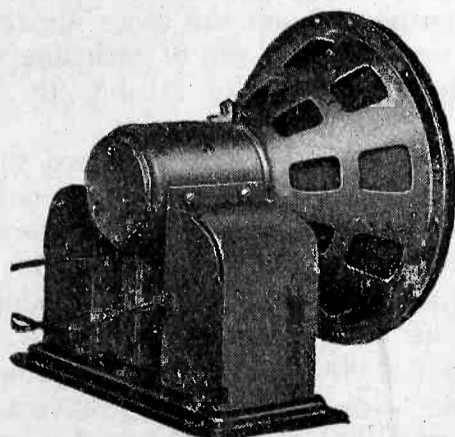

Jensen Dynamic Units
TYPE D-4 A.C.
(110 Volt Operation)

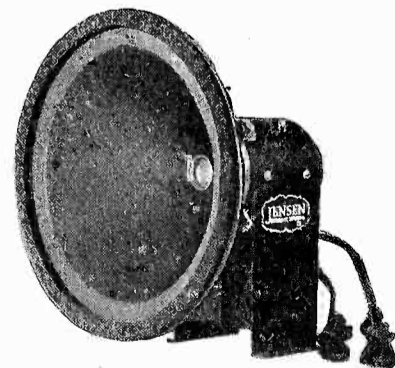

Jensen Dynamic Units
TYPE D-4 (6 Volt Operation)
TYPE D-5 (90 Volt Operation)

JENSEN
RADIO MFG. COMPANY
212 Ninth Street 35 E. Wacker Drive
OAKLAND, CALIF. CHICAGO, ILL.

A special two-color folder describes the complete line of Jensen Dynamic Speakers. Write for a copy.

Licensed under Magnavox Patents

Tell them you saw it in RADIO

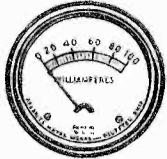

R. R. Panel Meters

IMPROVE YOUR SET

Use them to maintain accurate voltages and currents so maximum reception efficiency is assured.

No. 390

Cat. No. Type Price

Panel Voltmeters

326	For reading DC voltages, 0-6 volts	\$1.65
335	For reading DC voltages, 0-8 volts	1.65
310	For reading DC voltages, 0-10 volts	1.65
316	For reading DC voltages, 0-16 volts	1.65
337	For reading DC voltages, 0-50 volts	1.65
339	For reading DC voltages, 0-100 volts	1.75
342	For reading DC voltages, 0-150 volts	1.75

Panel AC Voltmeters

351	For reading 0-15 volts AC	\$2.25
352	For reading 0-10 volts AC	2.25
353	For reading 0-6 volts AC	2.25

Panel Milliammeters

311	For reading 0-10 milliamperes DC	\$1.95
325	For reading 0-25 milliamperes DC	1.85
350	For reading 0-50 milliamperes DC	1.65
390	For reading 0-100 milliamperes DC	1.65
399	For reading 0-300 milliamperes DC	1.65
394	For reading 0-400 milliamperes DC	1.65

DC Pin Jack Voltmeters

306	For No. 25 and No. 28 Radiolas, 0-6 volts DC	\$2.50
308	For No. 20 Radiola, 0-6 volts DC	2.50

"B" Eliminator Meters

346	For testing B battery eliminators, grid bias voltage across resistors, batteries, etc.; 0-300 DC scale	\$4.50
347	For same as No. 346, except scale is 0-500	5.50

BRUNO "Book of Hook-ups," 25 cents
Mail Orders Promptly Filled

Send for Free Catalog

B. C. L. Radio Service Co., Inc.

218 Fulton Street New York City

Resumption

of Service by

GERALD M. BEST

THE demand for properly matched Intermediate Frequency Transformers has caused the resumption of this one service by *Radio's* Calibration Laboratory. The matching is personally done by Gerald M. Best, technical editor of *Radio*. Prompt and accurate matching is assured. As D. B. McGown is no longer associated with this laboratory, no other testing or repair work is done.

Mail orders are solicited when transformers are carefully packed in box suitable for re-shipment.

Price \$3.00 per set

Calibration Laboratory

Pacific Radio Publishing Co.

433 Pacific Building

SAN FRANCISCO, CALIFORNIA

DATA ON A. C. RECEIVERS

(Continued from Page 24)

wave rectifier with type 81 tubes is used, and the field coil of the electro-dynamic speaker which is a part of this amplifier is used as the main filter choke. Another

HARMONIC CALIBRATION

(Continued from Page 23)

Personally, I often prefer to use this method even though the apparatus to be measured is within the range of my wavemeter; because it often happens

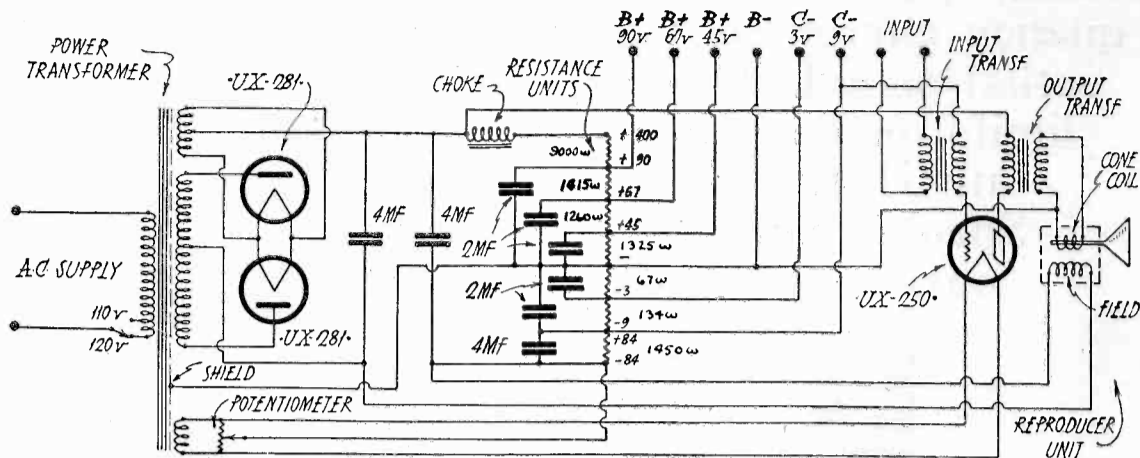

Radiola 105

filter choke is used between the positive high voltage tap and the low voltage terminals for supplying B power to a radio receiver, and in the resistance strip which is the voltage divider, taps for C voltages of 3 and 9 volts are also provided. The amplifier itself is a one-stage transformer-coupled affair, and is intended to follow the first audio stage in a receiver.

SIX-TUBE SET

(Continued from Page 18)

made with regular flexible hook-up wire.

The completed receiver should be wired up, preferably, with an automatic filament or B eliminator switch so that when the filaments of the receiver are lighted the a.c. current is also turned on. A high resistance voltmeter should be used to check the plate and grid voltages delivered by the B eliminator when all tubes are turned on. If the wiring diagram is followed closely and good apparatus is used, no trouble should be experienced.

In setting up the receiver for the first time, some fairly distant stations should be tuned in and the various circuits adjusted to resonance by means of the trimmer condensers. This should be done while rotating the dial controls back and forth until the set is most selective and the signal is loudest. The trimmer condenser across C_4 should be adjusted finally at the same time as the regeneration is adjusted.

The regeneration should be adjusted so that the detector just oscillates over the whole tuning band and then C_{11} should be reduced until the desired amount of regeneration is obtained. The more the regeneration the poorer the quality, but the greater the sensitivity. These adjustments on the regeneration should be made with the volume control rheostat turned up full.

If the detector regeneration is set high, remarkable dx is possible.

that when the two fundamentals are together, the resultant beat is so strong that it is difficult to get an accurate reading.

Fig. 1 shows what to expect when a "varying" apparatus is beating with a fixed apparatus; it being assumed that both are emitting up to the tenth harmonic. Here we find the ratio of the setting of one apparatus to that of the other plotted along the base, on a logarithmic scale, the fundamental of the fixed apparatus being considered as 1. The only reason for using a logarithmic scale was to reduce the size of the diagram and it should be kept in mind that, in reality, the distance between any two consecutive numbers is the same, i.e.: the distance between 7 and 8 is the same as that between 1 and 2, etc. The strength of the resultant beats is approximately shown by the height of the vertical lines, assuming that each harmonic is weaker than the preceding one. It will be noted that when the two fundamentals are together, the line goes off the scale. It actually rises to 20.3 on the scale used. This is due not only to the fact that the strength is the greatest when the two fundamentals are beating together, but also because every harmonic is beating with the corresponding harmonic from the other apparatus. The figures at the top of each line show which harmonics are causing the beat note.

A beat note between the two fundamentals is not a pure note, but is composed of a fundamental and its consecutive harmonics, both even and odd. To illustrate this let us say, for example, that one tube is oscillating at 20 kilocycles (20,000 cycles) and the other at 21 kilocycles, so that we will have a beat note of 1,000 cycles. Now the second harmonics of 20 k.c. and 21 k.c. are respectively 40 k.c. and 42 k.c. and the resultant beat note of these second harmonics will be 2,000 cycles, or the second harmonic of 1,000 cycles. Likewise

(Continued on Page 36)

THE ONLY REASON WE ADVERTISE

*is to tell people in print what we would
like to tell them face-to-face if we could*

THIS advertisement is written straight from the shoulder to you men who want better radio reception but don't know how to get it. You have read a lot of conflicting claims. You wonder what the real low-down is. You are ready to act, when you know you are right.

For the last three months you have read the facts about Infradyne performance in our advertisements in this publication. You have read what actual users say about the reception they are getting. Now, you are ready to act. Well, it is costing us a dollar a word to tell you to act promptly. There is no reason for any further delay.

BUILD IT OR HAVE IT BUILT

The 1928 Infradyne is a standard product. It is largely built up of proven Remler units. You can build it yourself or you can have it built by one of the thousands of professional set builders who understand it thoroughly.

They are a group of successful constructors, 50,000 strong, who build nationally-recognized circuits to meet the exact needs of their customers. If you do not know one, write us and we will mail you the names of several in your locality.

Once you have an Infradyne, you are radio-equipped for many years to come. In its lacquered copper cabinet and with its illuminated dial, it is a thing of beauty in any room.

Now go to it! Speed up. Summer-time reception carries a real kick when you have an Infradyne.

REMLER
GRAY and  DANIELSON
Manufacturing Company . . .

260 First Street
SAN FRANCISCO

NEW YORK

CHICAGO

Eastern Warehouse: ELKHART, IND.

Tell them you saw it in RADIO



A New A C Transformer

with Terminals for use with all types of Wiring Harnesses

Here is the latest A C success in the Dongan Approved A C line. No. 6570, built into a crystallized lacquered case, is equipped with terminals for use with the new wiring harnesses. Designed to operate with 4 U X 226, I U Y 227 and I U X 171 power amplifier tubes. Also equipped with lamp cord and plug outlet for B-eliminator as well as tap for control switch. Price \$6.50.

A Complete Line of Approved A C and Output Transformers By-Pass and Filter Type Condensers

for

SET MANUFACTURERS

and

CUSTOM SET BUILDERS

The reason you can expect real engineering help as well as par in modern design and construction is due to the fact that Dongan's entire radio business always has been devoted exclusively to the interest of the set manufacturer.

Ask for information and prices on any desired type, direct from Dongan to you.

See the Dongan Approved Parts Exhibit at the R. M. A. Show

DONGAN ELECTRIC MFG. CO.
2981-3001 Franklin St., Detroit, Mich.

TRANSFORMERS of MERIT for FIFTEEN YEARS

"RADIOBUSTER"

112 Page Book of Radio Fiction by Mathison
\$1.00 POSTPAID
"RADIO," San Francisco



Wireless or Morse—at home with the TELEPLEX Automatic Code Instructor. No better method for self-instruction exists. Quick—Easy—Thorough. Endorsed by U. S. Navy. The only instrument that Reproduces actual sending—messages, radiograms, etc. Any speed. Complete Course (6 tapes) FREE. Thirty times as many words as any other instrument. Avail yourself of the TELEPLEX for a quick mastery of the code. Write for booklet R. TELEPLEX CO., 76 Cortlandt Street, New York.

(Continued from Page 34)

the third harmonics, 60 k.c. and 63 k.c., will produce a beat note of 3,000 cycles, etc.

This will not occur if the harmonics are eliminated from one of the oscillators. In fact this gives one of the simplest

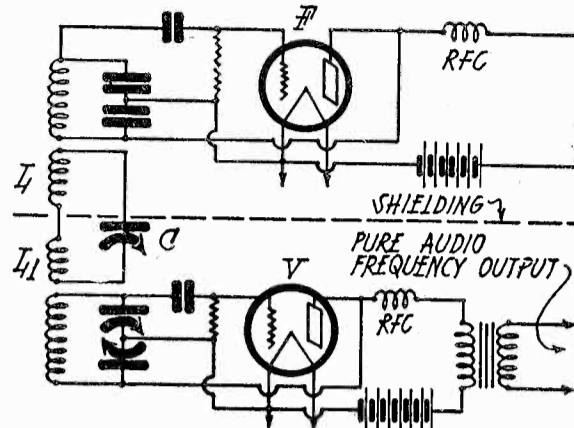

Fig. 2. Circuit Diagram of Variable Audio Frequency Generator.

ways of designing a variable audio frequency generator, having an output free of harmonics. Such a generator is shown in Fig. 2, where generator F is set to some constant radio frequency to which the circuit L, C, L_1 is tuned. Now remember that a simple resonant circuit such as L, C, L_1 is only tuned to one frequency and, therefore, if it is tuned to the fundamental of the oscillator F , it will transfer this fundamental frequency to the variable oscillator V , but any harmonics that are present will not be transferred. Consequently, the resultant audio frequency beat note will, for all practical purposes, be free from harmonics. I say for all practical purposes, advisedly, because it will be noted that the variable oscillator F is using a grid leak and grid condenser and therefore there is rectification taking place in the grid circuit and then a second rectification will take place in the anode circuit, thus giving a possibility of weak harmonics in the audio frequency output. Obviously, a better method would be to eliminate the grid condenser and leak and use an oscillator with a C battery for the variable oscillator.

TELEPHOTO TRANSMISSION OF MOTION PICTURES

(Continued from Page 10)

panies are expected to make frequent use of the process in the transmission of special news events, which may be simultaneously transmitted from one sending station to all the cities in the country where receiving equipments are now installed. The cost of sending thirty feet of film to all parts of the country would be about \$1000.

It should be understood, however, that this is not television in any sense of the word, as the motion picture becomes animated only after it is received at the receiving end, developed, printed, and spliced together into a continuous strip of film to be shown in a projector.

Tell them you saw it in RADIO

Quality Radio Products INCLUDE Potter Condensers

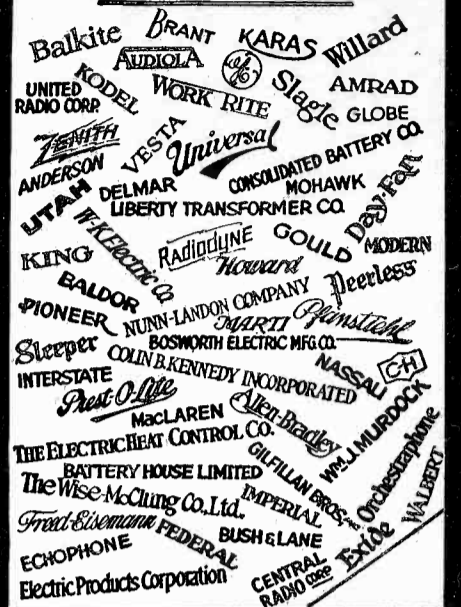

Potter Manufacturing Co.
No. Chicago, Ill.

Pacific Coast Offices
905 MISSION STREET
San Francisco California

Reputation

AMONG those who know radio, the name "Browning-Drake" stands for a development in the radio art that has won friends everywhere.

Complete factory-built receivers, ranging in price from \$95 to \$260, are offered to meet any requirement for radio reception. For three years Browning-Drake Kits have been the most popular on the market. Now a new loud speaker, licensed under Whitmore, Air-Chrome, patents pending, which reaches nearly an octave lower than the average speaker, is being manufactured by Browning-Drake.

In a word, the reputation of Browning-Drake has been built and is being maintained by designing and manufacturing radio products that supply the demand for something better.

The Browning-Drake Corporation
110 Brookline St., Cambridge, Mass.

BROWNING-DRAKE
RADIO

again-

The publishers of "RADIO"

ANNOUNCE

—the premier showing of new radio models in the July issue of RADIO—out on June 28th, a few days after the Radio Manufacturers' Association Show closes in Chicago. This PREMIER NUMBER will bring to you the very latest of radio's new developments for the 1928-1929 season. It will be the first consumer magazine to feature a complete "Style Number." New sets, parts, kits and accessories will be illustrated in what promises to be the largest issue in our history. This information will be rushed to us from Chicago on June 15th. Ten days later the PREMIER NUMBER will be on the street. 30,000 copies are reserved for the radio trade.

Any dealer, jobber, distributor or manufacturer who writes us for a copy of this special number will be supplied with same—free of charge—if this request is made on the company's letterhead. Individuals can send 25 cents now to insure prompt delivery of copy. Use the coupon below—attach 25 cents to it and mail now. The demand for copies of this special number will be greater than the supply. Dealers, particularly, should not fail to write for their free copy. The PREMIER NUMBER of RADIO will be the 1928 fall season reference guide of the industry. Advertising copy for this feature issue can be accepted as late as June 10th.

Don't Miss It—

Mail Coupon NOW—

Last year's Show issue enjoyed an unprecedented national sale. Advertisers informed us that it was a highly profitable issue for them. Copy for the great Show issue should be mailed now.

ORDER FOR INDIVIDUAL COPY

"RADIO"
Pacific Building,
San Francisco, Calif.

Here is 25 cents in stamps or coin for which you will mail me a copy of the PREMIER NUMBER of "RADIO." It is understood that this copy is to be mailed no later than June 28th.

Name.....

Address.....

City and State.....

DEALER'S ORDER COUPON

Paste This Coupon on Your Business Letterhead

"RADIO"
Pacific Building,
San Francisco, Calif.

We are radio dealers, as shown by our letterhead,—and we request that you send us a free copy of your PREMIER NUMBER of "RADIO" on June 28th. It is understood that this places us under no obligations.

Name.....

Address.....

City and State.....

Tell them you saw it in RADIO

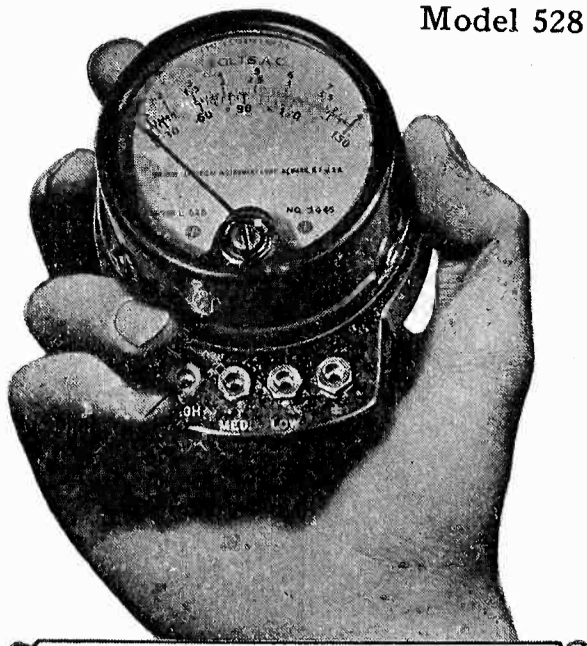

Model 528

Three Ranges—150/8/4 Volts for Testing A. C. Receivers

For checking up supply and tube voltages—a small, compact and portable instrument of highest quality and electrical performance, yet moderate in price. Open scales, responsive and excellently damped. At all dealers or write to

Weston Electrical Instrument Corporation

600 Frelinghuysen Ave., Newark, N. J.
Pacific Coast Representatives:

GRAYBAR ELECTRIC COMPANY, Inc.
84 Marion Street
Seattle, Wash.

J. H. SOUTHARD
San Francisco, Calif.

A. A. BARBERA
Los Angeles, Calif.
REPAIR SERVICE LABORATORY
682 Mission Street
San Francisco, Calif.

WESTON RADIO INSTRUMENTS

NEW BOOKLET

On Audio Amplification, A. C. and D. C. Power Amplifiers, and Specially Developed Receivers—How to Get Better Tone, Volume and Power.

Newest circuits. 30 pages with diagrams and photographs.

Send 10c to cover mailing cost

FERRANTI, Inc.

130 West 42nd St., New York, N. Y.

POWER UNIT

Save 75% of cost of Electro-Magnetic Power Unit. All parts factory-made—easily put together—A modern driving unit in knockdown form—complete only \$6.75. Send for circular or send us your order—GUARANTEED.

TUNBAR RADIO CO.

26 Cortlandt St., New York

Send for Free Catalog

Airplane Cloth Speaker

It contains many bargains in all types of Cone Speakers, Units, complete parts to build all types of cone speakers. Also the latest parts of the New AIR-PLANE Cone Speaker. Accessories. ACCUSTI-CONE, 1 No. 7th St., Phila., Pa.

RESISTORS FOR VOLTAGE DIVIDERS

(Continued from Page 20)

it again. That is not serious when we first start up the set but you can see that it would not improve the quality if the voltage kept shifting from 90 to 125 and back while we were listening to a program. The game is to pick out such a value of the resistor R_{11} that there shall be a continuous flow of about 25 milliamperes through the tube all the time. We do it this way. If, for example, there were normally 35 m.a. flow in R_{10} we should make R_{11} 9000 ohms so that 10 m.a. would flow through it, which would leave 25 to flow through the tube. If more m.a. should flow through R_{10} the extra ones would flow through the tube, and if less should flow, then the tube would not pass so many and we would have a constant flow through R_{11} . The various types of glow tubes made by various manufacturers all have slightly different characteristics so you want to be sure to figure on the ones of the particular tube that you want to use.

Yes, we can make variable output resistors that will allow us to match the B-supply to any set. But so far there are but a few who make variable resistors suitable for that use. There are a couple or so makes of excellent fixed resistors in which the wire is not covered with enamel so that it is a simple matter to tap them where you choose.

BAND PASS FILTERS

(Continued from Page 25)

tube does not regenerate properly, the B voltage should be increased to take care of the voltage drop through the resistance. The tuned input transformer ordinarily used between the mixer and first i.f. tube may be used as the output termination.

In lining up the filter it will probably be necessary to adjust the shunt tuned circuits to a frequency slightly less than 115 k.c. by turning the set-screw on the top of each inductance, in a clockwise direction. This filter introduces a loss into the circuit and cuts down the gain. But this is more than compensated for by the great amplification of the i.f. stages. However, it should not be placed between the two i.f. tubes or between the last i.f. tube and the detector, where the losses would prohibitively impair the sensitivity of the set.

Electric power companies generally recognize their responsibility for clearing major sources of interference to local reception as caused by power lines and equipment, but they do not accept responsibility and incident costs for clearing minor cases that interfere with long distance reception.

Tell them you saw it in RADIO

Practical Radio Telegraphy

A new book, worthy of a place in any radio man's library. Written by Arthur R. Nilson, Director West Side Y.M.C.A. Radio Institute, New York and J. L. Hornung, Chief Instructor, West Side Y.M.C.A. Radio Institute, New York. A book expressly for radio students preparing to become radio operators. A fine general handbook for those having to use and care for modern radio transmitting and receiving equipment. Every commercial operator should have this very latest down-to-the-minute book. Wonderful help to those who contemplate taking commercial operator's examinations.

380 PAGES

Bound in cloth. 223 illustrations. Will be sent postpaid upon receipt of price to any part of the U. S. or Canada. Edition limited. Prompt action necessary. **\$3.00**

PUBLISHERS OF "RADIO"

433 Pacific Building San Francisco

SEND FOR FREE CATALOG
From Chicago's Oldest Radio Jobbers. The Most Valuable Radio Catalog. Write for your copy today—IT'S FREE! TELEPHONE MAINTENANCE CO. 123-5 S. Wells St., Dept. 79, Chicago, Ill.

DEPENDABLE! EVERLASTING!

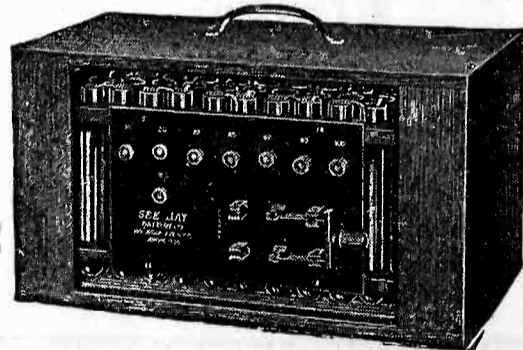

100 Volt Edison Element, Non-Destructive Rechargeable "B" Battery with Charger.....\$12
140 Volt with Chemical Charger.....\$17
180 Volt with Dry Trickle Charger.....\$24

Complete knockdown batteries, all sizes at reduced prices. Detector and intermediate voltages plainly marked. Greater volume and clearer than any other eliminator.

Use this coupon to receive our interesting booklet.

SEE JAY BATTERY COMPANY
913 Brook Ave., New York, N. Y.

Please mail me at once your FREE illustrated booklet describing your batteries and power units, without any obligation to me.

Name

Street & No.

Town..... State.....

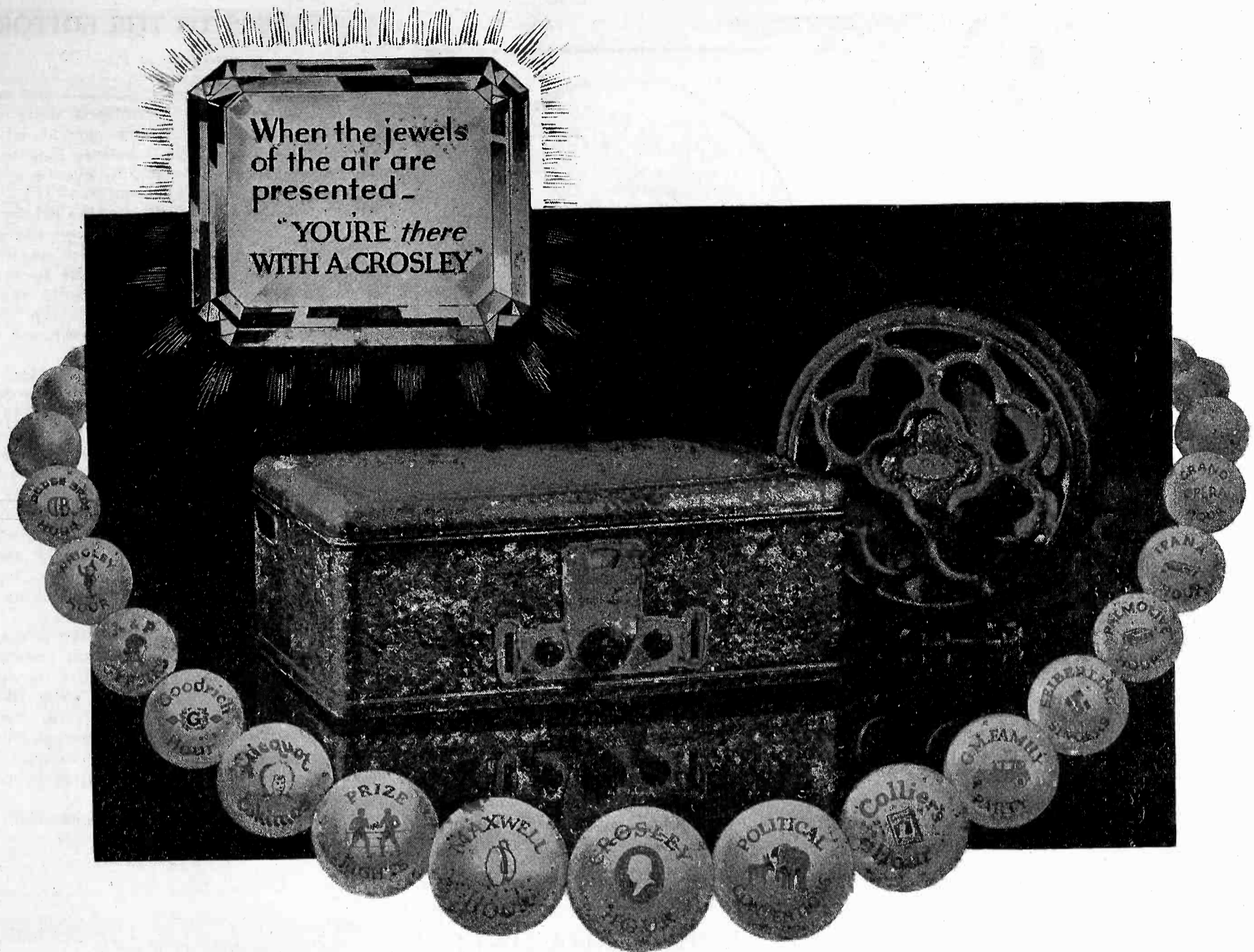

The New CROSLEY JEWELBOX

\$95
WITHOUT TUBES

Take advantage of the most amazing offer ever made in all Radio History!

Try this remarkable new Crosley Radio with Crosley new type D Musicone without cost or obligation. Just phone a Crosley dealer—tell him you want to test the new Crosley Jewelbox.

Home is really the place to buy radio!

Home is where you can decide leisurely and surely. Crosley dealers are authorized to home demonstrate this new radio. Antenna unnecessary for such demonstrations—30 feet of wire on the floor of the room will do nicely.

Put the Jewelbox to any test!

Compare it with your old set. Try it with any other! Learn what radio reception can be. Note how easy it will be to break through any surrounding wall of local stations—to bring in distant programs quickly, clearly and in full volume. Be sure you test the Jewelbox with the Crosley new type D Musicone that you may fully realize, if you own an old set or have not heard a Crosley, how far radio has progressed. Remember—you do this all in your own home—at no cost and no obligation to you!

Buy Radio Reception—not Furniture!

The Jewelbox is a radio fine enough to go into the finest furniture you can buy and as such is easily installed—but it is distinctive, decorative and desirable by itself. In Crosley radio you buy perfect reception and radio enjoyment first!

*Try it in your home
—that's the only way
to buy a Radio!*

*Every Crosley Dealer
is now authorized to
give you this FREE
trial!*

THE CROSLEY RADIO CORPORATION
Powel Crosley, Jr., Pres. Cincinnati, Ohio

*Licensed only for Radio Amateur, Experimental
and Broadcast Reception
Montana, Wyoming, Colorado, New Mexico and
West prices slightly higher*



The Musicone finished to match the Jewelbox, \$15

The new Crosley Jewelbox is self-contained to operate from light socket.

All in one beautiful case. Add tubes and it's ready to operate! It is powerful. Supplying 180 volts to power output tube it gives full undistorted volume. Other sets supplying 110 to 135 volts result in poor quality, distortion and less volume.

The new Jewelbox is acutely selective.

The Acuminators, an exclusive Crosley feature enable you to tune sharply on distant stations increasing signal strength and volume to a surprising degree.

The new Crosley Jewelbox is up-to-date.

The dial is illuminated—a modern necessary feature. The set is completely shielded as all high grade radios should be. The rich brown finish high-lighted with gold makes it an ornament to grace the finest room. The beauty of the Jewelbox will charm you.

The price of the new Jewelbox is a triumph of manufacturing genius!

Crosley engineers designed this new Crosley Jewelbox under explicit instructions to make first a perfect radio. If the production of their final design had been limited to a few hundred, only wealthy persons could have afforded them. But with efficient Crosley production methods, facilities to manufacture parts in million quantities and a faith in the enormous demand such values would create, this splendid radio receiver is priced at \$95.

Write Dept. 19 for literature.

Tell them you saw it in RADIO



Jewell
Lightning Arrestor

Your Set Needs Protection

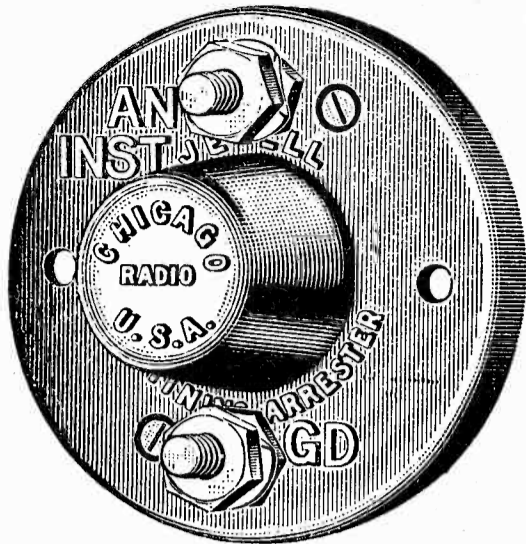

It is hardly reasonable to put your money into an expensive radio set without providing it with the best possible protection against lightning. People are doing this every day and risking the chance of severe damage if not complete destruction of the delicate mechanism in their radio set.

The Jewell Lightning Arrestor will provide as good protection as can be obtained. It consists of a glazed brown porcelain case enclosing an accurately calibrated air gap. The case is sealed with a moisture proof compound which makes it equally suitable for indoor or outdoor installation.

As a further indication of the reliability of the Jewell Lightning Arrestor, it has passed all tests prescribed by Underwriters' Laboratories and is listed as Standard by that organization.

Ask your dealer to show you one or write for descriptive circular No. 1019.

Jewell Electrical Instrument Company
1650 WALNUT STREET, CHICAGO
"28 Years Making Good Instruments"

WHAT'S WRONG WITH YOUR SUPER?

Jeems Super Trouble Shooter, most complete, accurate, sure-fire method of locating trouble in any superheterodyne. Chart comprises 16 symptoms, 130 possible causes; result of ten years' trouble finding on supers. By mail 50 cents.

"A DOLLAR A MINUTE"

One set builder writes:

Los Angeles, Calif.
"Made \$5.00 in five minutes servicing a super no one had been able to fix. Your Jeems chart showed me the trouble in a minute."

J. B. R.

It's easy to locate trouble with a Jeems Super Trouble-Shooting Chart. Quick, handy, accurate.

ROBERTS RADIO SERVICE
Caxton Building
Chicago, Ill.

2 RADIO MAGAZINES for the price of one

CITIZENS' RADIO CALL BOOK and RADIO. One full year subscription to each for only \$2.50, the price of RADIO alone. "RADIO," 433 Pacific Bldg., San Francisco.



Now the famous Hammarlund low-loss, space-wound coils may be had in plug-in form. A set of three coils covers the low-wave band from 20 to 80 meters. Special coils supplied for higher wave lengths. The variable primary coil has phosphor-bronze flexible connections and is integral with the Bakelite base. Friction holds it at any desired coupling.

Write for special folder

HAMMARLUND MANUFACTURING CO.
424-438 W. 33rd St., New York

For Better Radio
Hammarlund
PRECISION PRODUCTS

Tell them you saw it in RADIO

LETTERS TO THE EDITOR

(Continued from Page 29)

are printed every month. This is not at all a criticism of RADIO. I suggest more such articles and, perhaps, more careful editing of them, simply because I believe they would be, in the end, of benefit to everyone concerned with radio.

I do wish, however, to consider briefly one or two points in Mr. Case's paper. On page 40 he discussed resistance coupled amplifiers. In his method of determining the necessary B voltage to obtain 90 volts actually applied plate potential, he makes use of the "plate impedance" of the tube. This procedure will not give nearly the correct result.

If we assume that at 90 volts plate and -4.5 grid bias the plate current of a 201A tube is 2 mls, the voltage drop in the 15,000 ohm plate resistor, assumed by Mr. Case, is only 30 volts. The applied B voltage, thus, should be about 120 volts, not 225 volts! Since it might be convenient, however, to apply as much as 180 volts, it can similarly be shown that 40,000 ohms could be used as a plate resistor and still one would obtain approximately 90 volts on the plate. 40,000 ohms is a better value than 15,000 ohms for several reasons.

In computing the value of the blocking condenser, Mr. Case assumes that resistance and condensive impedance are directly additive. This assumption leads to a value of the blocking condenser much larger than necessary. The disadvantage of a large condenser, as he mentions, is the relatively longer time required to discharge it if the grid is made positive by static, etc.

A more nearly correct expression follows:

$$e_g = \frac{R_g e_p}{\sqrt{(R_g + R_o)^2 + \frac{1}{\omega^2 C^2}}}$$

where:—

e_p = signal voltage on plate
 R_o = output resistance (plate)
 C = capacity of condenser
 R_g = input resistance (grid resistance with resistor)

e_g = signal voltage on grid

A little study of the derivation and application of this expression with e_g assumed, say 85-90% of e_p at the lowest frequency, is quite enlightening and shows why some of the old resistance coupled circuits, though poor enough, were, perhaps, not as bad as they might have been, were nature as Mr. Case believes. You also see why R. C. A. recommend condensers as little as .006 m.f. for this purpose.

Both of these errors mentioned are commonly made and should most certainly be corrected. One prominent transformer manufacturer, by making both of them also, has doubtless done much to discourage the use of relatively the cheapest, and if properly designed, probably the most perfect of all audio amplifiers.

Very truly yours,

E. H. KURTH.

Box 105, Palmsdale, California.

Sir:—I am returning herewith the letter of Mr. Kurth, which you sent me for comment before publication. I am very glad indeed to see that people are taking such an intelligent interest in articles of a semi-mathematical nature.

To take up the points which he brings out in more or less their proper order: his first point is well taken. Of course, the error in the article lies in the fact that I inadvertently took the a.c. plate resistance of the tube instead of the d.c. plate resistance. The d.c. resistance is obtained by dividing the steady plate voltage by the steady plate current. For an 01-A tube under the conditions speci-

(Continued on Page 42)

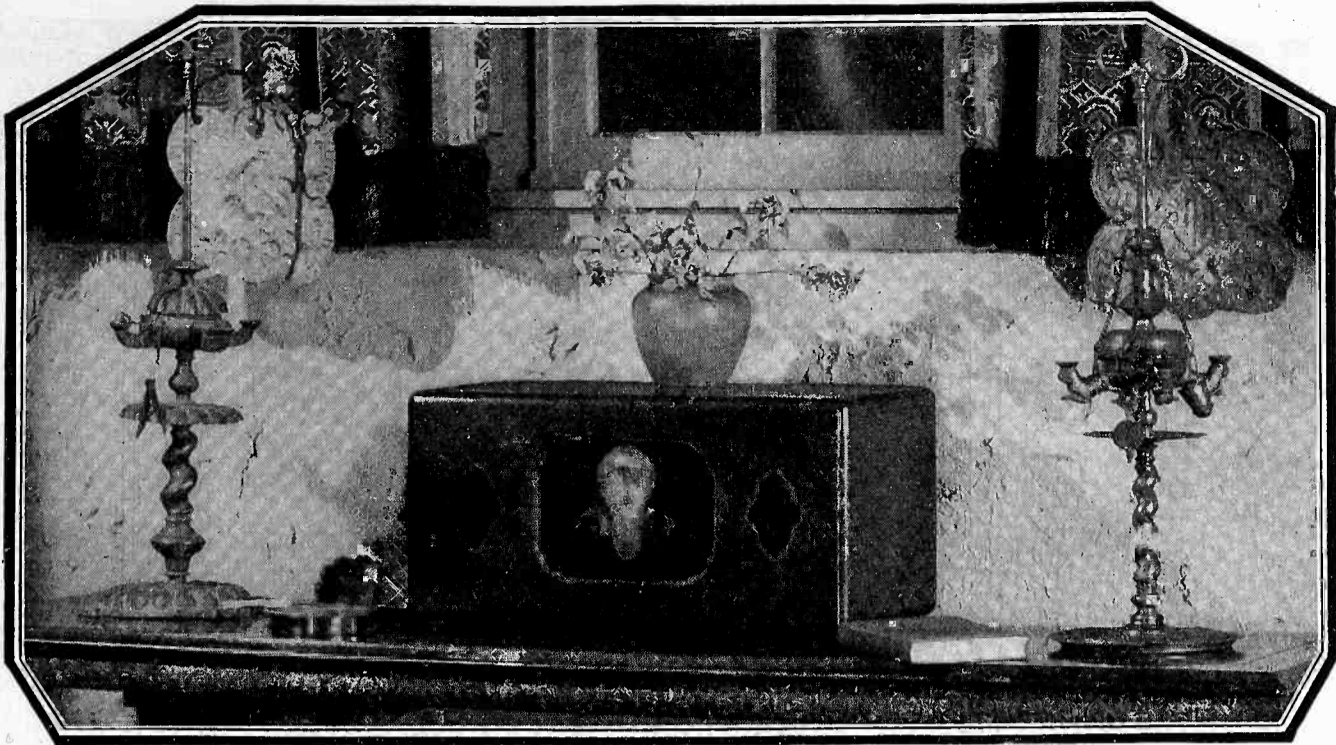

What Others Say

Salt Lake City, Utah.
Oct. 13, 1927.

My Bremer-Tully Receiver has given entire satisfaction and I am of the opinion that I have just a little better outfit than the other fellow.

It has been my experience to bring in stations within a radius of 2,000 miles. This is considered very good in this locality.

C. P.

Ft. Worth, Tex.
Dec. 27, 1927.

I know nothing about radio other than to state that the Bremer-Tully which I purchased in 1925 is still the best I ever saw. I am using the same tubes that came with it, and getting results.

Livingston, Mont.
Dec. 23, 1927.

Out here in Montana far away from broadcasting stations, we have to have a good radio to bring them in. Although I have heard many I never heard one that I could say I wanted until my friend brought me down to hear his Bremer-Tully. I now have one like it and have been able to get the best kind of reception every night and everybody says it is the best set they have ever heard.

J. V.

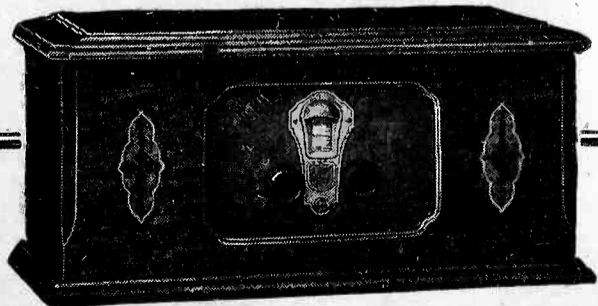

The 6-40 is furnished in two cabinet styles—Model "R" illustrated at the top of the page and Model "S" illustrated above. Both are of equal size.

Bremer-Tully

RADIO

SINCE the earliest days of commercial broadcasting every Bremer-Tully radio product has been a continued outstanding success.

Six years of progress—and a reputation second to none—Bremer-Tully start their seventh season with the finest receiver in its class, the new 6-40.

It is the culmination of these years of experience, the result of many months' intensive effort and development.

Simple, compact, self-contained, the 6-40 embodies all those features and refinements that are responsible for the traditionally fine Bremer-Tully quality—and at the amazingly low price of \$136.00.

A radio set that surpasses everything at anywhere near its price in musical reproduction—a set that excels in general performance as well.

See it, hear it, compare it—you will be convinced that here is the greatest radio value ever offered.

The coupon will bring descriptive literature and name of our dealer in your community.

Bremer-Tully Mfg. Company
520-532 SO. CANAL ST., CHICAGO

Name.....

Address.....

City.....State.....



Used in

Every High Grade Circuit or Receiver Today!

X-L NEW BAKELITE INSULATED PUSH POSTS

The perfect binding post at last! Convenient, simple; permanent connections. You don't have to remember to tighten them. Push down the X-L, insert wire, remove pressure. Connection is tight and will stay tight. No vibrations can loosen. Release instantly. Engraved in all standard markings. Price each, 15 cents.



FREE Big new up-to-date book of wiring diagrams of all leading circuits. Write today for copy.

XL Radio Laboratories

Dept. J, 1224 Belmont Ave., Chicago, Ill.

NEW SHIELDED SUPER-10

5 Screen Grid R. F. Amplifiers

4 Stage Power A. F. Amplifier

A new and Superior Receiver, representing highest type of efficiency obtainable, in point of extreme range, selectivity, and quality of reproduction.

Illustrated literature gratis

Complete Constructional Blue Prints, \$2.00, postpaid

NORDEN-HAUCK, INC.

Builders of Highest Class Radio Apparatus in the World

Marine Bldg., Philadelphia, Pa.

Cable Address "NORHAUCK"

THERE IS A

FERRANTI

Audio Frequency Transformer for every requirement

Get the very best in audio amplification. Know how to use it. The 1928 Ferranti Year Book contains 60 pages of useful information, including circuits and instructions for building receivers, power amplifiers, etc. Sent anywhere for 15c in coin. Stamps not accepted.

FERRANTI, INC.

130 West 42nd St., New York, N. Y.

(Continued from Page 40)

fied, it is roughly 45,000 ohms, a value quite a bit different from that which I employed.

Mr. Kurth suggests the use of 180 volts in the plate circuit, with a corresponding coupling resistance of 40,000 ohms, stating that the latter is better than the 15,000 ohms which I suggested, for several reasons. It is true that the gain per stage will increase from about 4.8 per stage to about 6.4 per stage. Under certain circuit conditions, in fact under *most* circuit conditions, this advantage is sufficient to warrant the use of the higher value. However, under some circumstances it would be advisable to use the lower value of resistance and increase the C battery voltage, thus giving a greater power handling capacity to the tube. Also, the greater the negative bias on the grid, the less the likelihood of the grid going positive under strong signals, and thereby blocking the tube. I must confess complete ignorance as to the other advantages of the higher plate resistance intimated by Mr. Kurth. One of them might be the lower plate current drain, but that hardly seems of importance in this day of light socket operation.

As to the second point brought out by Mr. Kurth, he is undoubtedly right as far as the simple fact of the phase relations goes. I purposely treated the problem the way I did, as I find that there is no subject in elementary electrical theory that the average person finds more difficult to grasp than the idea of phase. Treating the reactances as directly additive makes a picture which is so simple to grasp that anyone with even the most rudimentary training in direct current circuits can understand the idea perfectly. The results, of course, do give somewhat larger values of capacity than are really necessary, but the difference is not large enough to make any appreciable difference in the cost of the condenser. The use of the larger value will only give a little better reproduction than we figured for. As for his objection that the larger condenser takes longer to discharge in case the grid goes positive, while it is undoubtedly true, nevertheless, that should have no great bearing, since the circuit should be so designed that the grid will not go positive under the strongest signals received.

The equation which Mr. Kurth gives on page three of his letter is correct in form, but I am unable to agree with his inclusion of R_o , the value of the output resistance of the preceding tube. While this quantity is not sufficiently large to make any great difference in the numerical results, its inclusion in the equation is not justifiable on theoretical grounds. As to just what is wrong with it, we must get a more definite evaluation for e_p . If e_p represents the quantity μe_g , then the equation in the form which he gives assumes that the impedance of the circuit through the grid condenser and leak is low compared to the resistance of the coupling resistor, which is, of course, not at all true. On the other hand, if we take e_p to represent the voltage built up across the coupling resistor, then we have progressed beyond the point where the constants of the preceding tube affect our calculations.

If we choose the latter assumption for e_p , the correct form of the equation is:

$$e_g = \frac{R_g e_p}{\sqrt{R_g^2 + \frac{1}{\omega^2 C^2}}}$$

Mr. Kurth states that, in view of the fact that I neglected the phase relations, I was led to bear down too harshly on some of the older resistance-coupled amplifiers. I do not believe that Mr. Kurth actually carried through the computation here, or he would have discovered just how little difference the phase relations do make. Let us take the amplifier mentioned in the article, with a blocking condenser of .006 mfd. and a grid

resistor of 50,000 ohms. On a basis of straight addition, the grid voltage is 8.6% of e_p at 50 cycles. Taking the phase relations into account, we find that the grid voltage is 9.3% of e_p . Both of these values can only be described as very bad, and I fail to see that the amplifier is vindicated to any appreciable extent.

I regret the error in the computation of the B battery voltage, and trust that this can be rectified to some extent in a forthcoming issue. As for the latter part of Mr. Kurth's comments, they hardly seem to alter the aspect to any great extent.

Very sincerely yours,

NELSON P. CASE.

RADIO KIT REVIEWS

(Continued from Page 32)

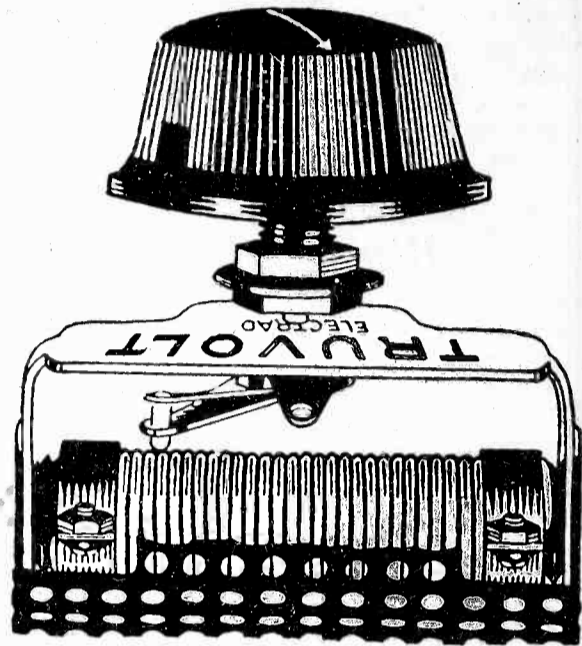

allows adjustment to care for any variation in line voltage or current drain.

The Thordarson Z-coupler is designed for use in an audio frequency amplifier using a shield grid and a power tube, going between the two. It consists of a grid and plate choke with a 0.5 mfd. coupling condenser and has an impedance of approximately one million ohms to match that of the shield grid tube. With the tube it is claimed to give a voltage amplification of 50 times without howling or a.f. oscillation. It gives a remarkably flat frequency curve with 95 per cent of the total amplification at 60 cycles and 87 per cent at 30 cycles.

The construction of radio beacons for aircraft is an important part of the Department of Commerce program. The Airways Division has plans for directional beacons to be placed at 200-mile intervals along the routes followed by air-mail and civil flyers, and marker beacons to indicate locations at 25 mile intervals. Plans are also being made for radiotelephone communication between planes and ground stations. Congressional appropriations already make possible the construction of a directional beacon at Cleveland, Ohio, and at Key West, Florida, similar to those at Headley Field, N. J., College Park, Md., Bellefonte, Pa., Dearborn, Mich., Chicago, Ill., San Francisco, Calif. Others will be built as funds become available.

The conditions under which molybdenite converts light into electricity are to be investigated by the U. S. Bureau of Standards.

Tell them you saw it in RADIO

AMATEUR TRANSMITTING ANTENNA

(Continued from Page 30)

heart, as there are other factors entering into it that make it rather approximate. Incidentally, the lengths of the two wires, 40 and 80 ft., are also rather approximate for the same reason, but it will be found that these lengths will vary but slightly in most cases.

Theoretically, the arrangement as described will work on 10 or 5 meters without any changes, but it has not been tried out on these waves at this station as it has on the others. If one has room enough, and desires to work in the vicinity of 160 meters as well, all dimensions should be doubled. That is, one wire will be 80 ft. long and the other 160 ft.

Don't be fooled because the antenna ammeter shows a little less current, but give it a tryout for a week or two and you will be convinced that it is O.K.

If, after everything is set up, you find that

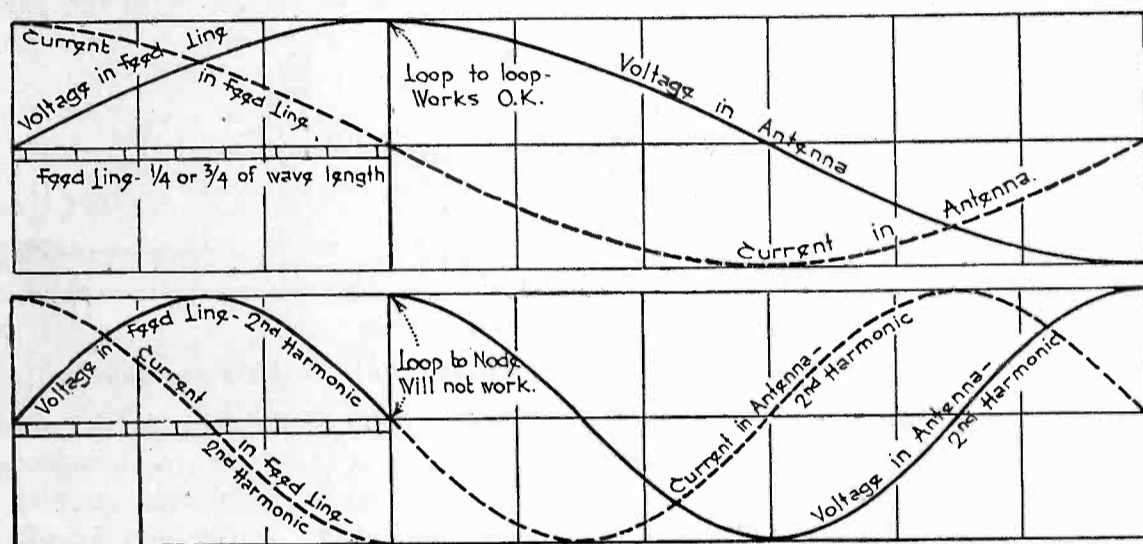

Fig. 3. "Zepp" Feed Arrangements

you get maximum radiation on one band, and much less on others, refer to the curve and make an accurate guess at what maximum you are working on, and clip or add wire accordingly.

Don't expect a "Zeppelin" arrangement to feed a straight Hertz on harmonics, as it won't work out (although you may get results after a fashion). The reason why is shown in Fig. 3. It would work if you could change the length of the feed line for each wavelength. If you are using such an arrangement now, and it appears to work, the thing is not working as a "Zepp." feeding a Hertz, but as something else that gets by.

Paper for testing the polarity of a terminal can be made by soaking filter paper in a solution made by dissolving one gram of phenolphthalein in a small amount of alcohol and adding 100 cu. cm. of 10 per cent solution of potassium chloride. By moistening a small slip of this dried paper a bright red stain appears when it is touched to a negative terminal.

A comprehensive plan for licensing radio manufacturers to use patents is to be presented at the R.M.A. convention in June. This is expected to settle many controversies over radio patents. The plan is similar to the patent cross-licensing plan of the automotive industry.

QUERIES AND REPLIES

(Continued from Page 26)

Is a cone speaker equal to a 7 ft. horn, considering both articles of equal quality? D. R. K., Manila, P. I.

It all depends on the place in which the loudspeaker is to be installed. If the horn is of the exponential type, such as is used in many of the modern phonographs, the directional effect is not bothersome, and it will cover the room equally as well as a cone speaker, but if the horn is straight and with relatively narrow mouth, the directional effect may be objectionable.

Would like to know if the Best 115 k.c. superheterodyne using the shielded grid tubes can be used on the short waves?—D. R. M., Chester Springs, Pa.

If the two stages of tuned r.f. are omitted, the receiver could be used on the short waves by the substitution of a short wave antenna coil for the present r.f. coil just ahead of the mixer tube, and by replacing the oscillator coil with another which is designed to cover the particular short wave band desired. The two r.f. tubes would not be used,

and the set would in effect be a 7 tube superheterodyne, with two stages of shielded grid i.f. amplification.

Why do most of the circuit diagrams in Radio show Ohms as the Greek letter ω and Megohms as Ω , when the reverse is considered standard practice?—R. E. L., San Francisco, Calif.

There has been considerable argument on this point, and authorities differ in their use of the symbols. The American Institute of Electrical Engineers, in their March, 1928, Proceedings, propose a complete group of electrical symbols in which the ohm is shown as Ω , and the megohm as ω . Prominent electrical corporations such as the Bell System and allied organizations use the letter ω exclusively for ohms, and of the various diagrams in a large number of publications which have been scrutinized, about half of them use ω as the symbol for ohms, and the other half use the letter Ω . To prevent confusion, we are identifying all resistances on our diagrams with the word "ohms" spelled out.

One advantage of socket supply for the plate voltage of a special detector tube is that the voltage can easily be shut off when the tube is not in use. If the plate voltage is maintained, as with a battery, the alkali vapor in the tube tends to disrupt and become conductive, eventually stopping the detector action or making the tube noisy. If batteries are used one terminal should be disconnected when the set is not in use.

Tell them you saw it in RADIO

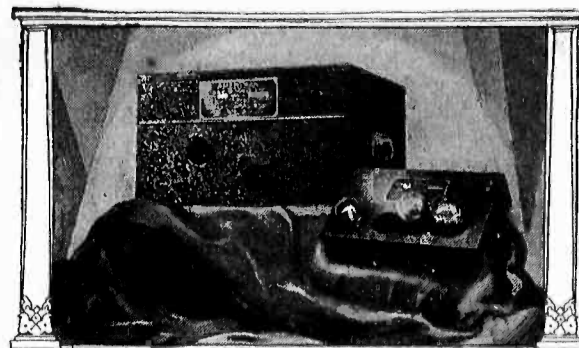

Is Your Set a 60 Percenter?

TOO many sets are delivering only 60% of the tones broadcast by the studio. Most of the audio systems choke off or distort the very tones which give that fullness and roundness which makes the difference between ordinary and Natural Reproduction.

Link up your Tuner to Natural Reproduction with the companion units, The AmerTran Push-Pull Power Amplifier and the AmerTran ABC Hi-Power Box.

You must hear it to appreciate it. Even your imagination will not exaggerate the difference. Write for full information or ask us to arrange a demonstration at your dealer's store, no obligation of course.

AMERICAN TRANSFORMER CO.

131 Emmet St., Newark, N. J.

Transformer Manufacturers for 28 years

AMERTRAN
TRADE MARK REG. U.S. PAT. OFF.

The Braid

Slides back

CORWICO
BRAIDITE
HOO-K-UP WIRE

Simply push back the insulation on Braidite, make your connection, solder it, and the insulation slides right back into place, leaving no exposed sections of bare wire. Braidite holds its shape permanently after bending, and you cannot scorch or burn it with a soldering iron. Braidite is the easiest and fastest working hook-up wire made, yet it costs less than ordinary hook-up wires.

If your dealer cannot supply you write us direct.
25 Ft. Stranded Braidite.....35c
25 Ft. Solid Braidite.....30c
Made in red, green, yellow, blue, and black.

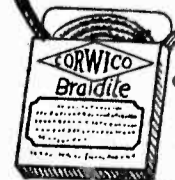
CORNISH WIRE CO.
30 Church St., New York



Electrify your battery set with the Corwico A-C Adapter Harness. No rewiring. Ask your dealer.



CONCENTRATED EFFORT!

In specializing on and perfecting condensers and resistors which have stood up under every test made to determine their worth, the Aerovox Wireless Corporation has attained a goal made possible only by perfect co-ordination, co-operation, and concentration of every element in an organization devoted exclusively to the production of high quality condensers and resistors.



The AEROVOX Research Worker

is a free monthly publication that will keep you abreast of the latest developments in Radio. A post card will put your name on the mailing list.

SEND TODAY!



AEROVOX

"Built Better"
70 Washington St. Brooklyn, N. Y.

"RADIO" and "CITIZENS' RADIO CALL BOOK"

One year subscription to both for \$2.50—the price of "RADIO" alone—if you subscribe now.

"RADIO," San Francisco

FREE RADIO BOOK!

40 pages chock-full of vital information for radio set builders. 14 new Aero circuits—receivers, transmitters, radiophones, short wave—fully described. Complete construction data, schematics, photos, etc. Exactly the book you've wanted. Write for FREE copy TODAY. Address AERO PRODUCTS, Inc., Dept. 103, 1772 Wilson Ave., Chicago, Ill.

SCIENTIFIC SET DESIGN

(Continued from Page 22)

less elaborate instruments for these measurements.

Fig. 8 shows the setup used in the measurement of the gain from the grid of the first audio to the grid of the last

stage, so that it can be used very nicely for such work.

The potentiometer is made of two decade boxes. The small one is set at 100 ohms and the large one has a maximum resistance of 1100 ohms. So a gain of 120 is easily measured.

In obtaining the a.f. gain of a single

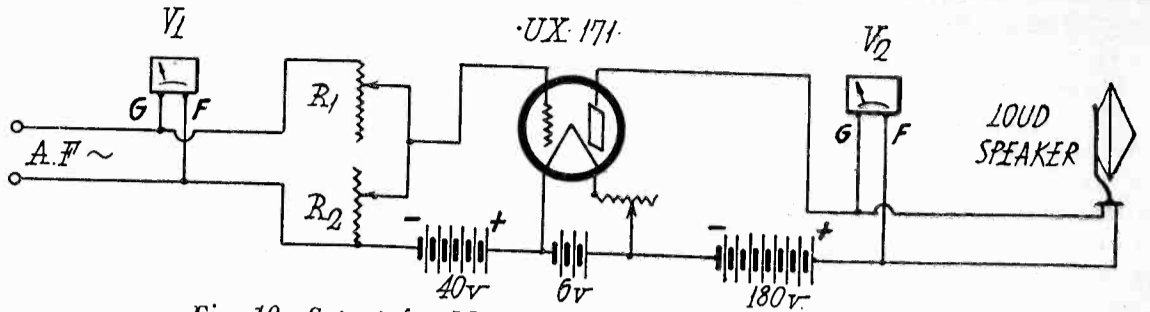

Fig. 10. Set-up for Measurement of Gain in Power Tube

audio tube. Instead of using a milliammeter as an input indicator we use another tube voltmeter across the potentiometer. This voltmeter is identical with the one used across the output and may

stage the input is adjusted until V1 reads about 5 volts, then R1 is adjusted until V1 and V2 indicate equal voltages, when the gain is equal to (R1 + R2)/R2. Thus if R2 is 100 ohms, R1 3000 the gain is

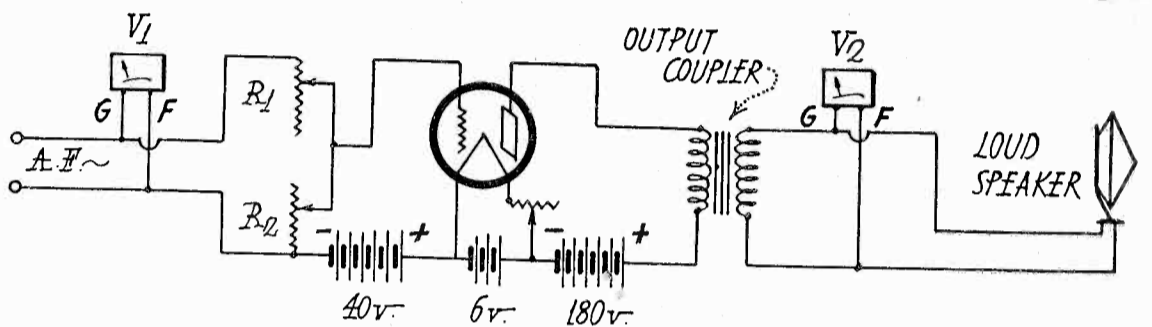

Fig. 11. Connection for Measuring Gain in Power Tube with Output Coupler

be made up according to Fig. 9. This shows a much simpler type of meter using a small d.c. milliammeter and no bucking-out voltage. In other words, the meter does not quite read zero on

(3000 + 100)/100 = 31. This process is repeated at different frequencies and when the result is plotted it gives a visual indication of the quality of the audio system.

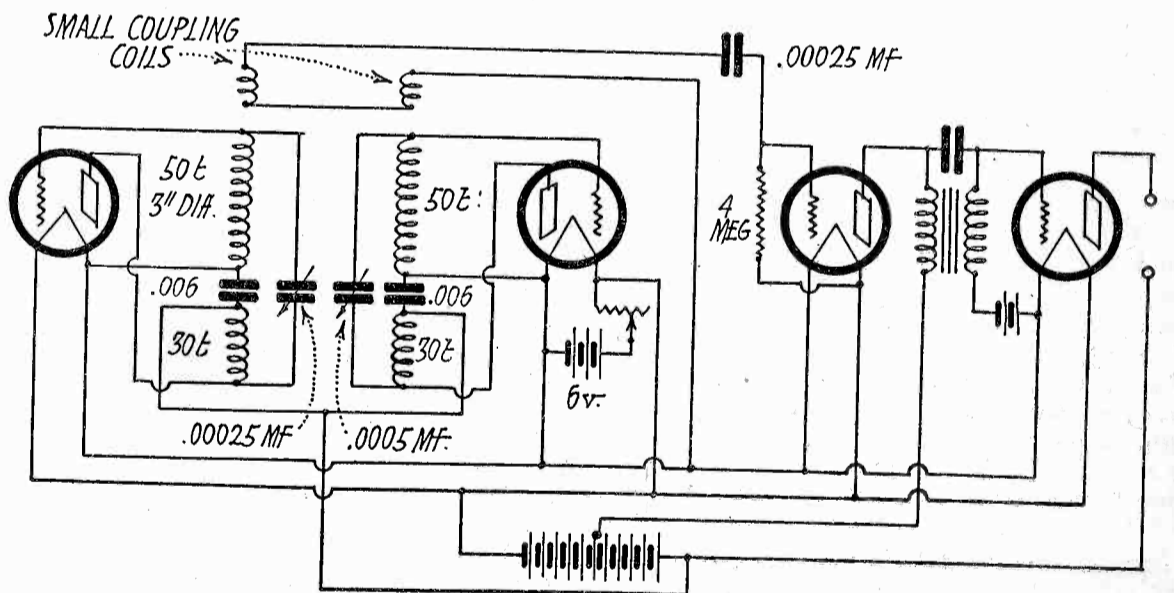

Fig. 12. Circuit Diagram of Beat Frequency A.F. Oscillator

no input, but instead reads very low on the scale. When the input is about 5 volts this type of thermionic voltmeter will give a reading of about 1 milliam-

To measure the gain through the power tube (last audio) use the circuit shown in Fig. 10 with two voltmeters and the same potentiometer. The second

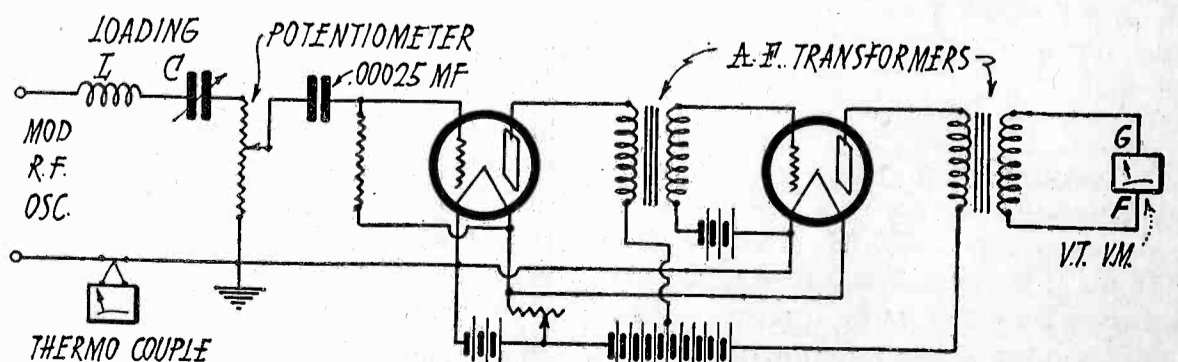

Fig. 13. Circuit for Measurement of Detector Gain

Tell them you saw it in RADIO

voltmeter has its *C* battery reversed and of different value than the first one. This is because the voltmeter is placed directly across the loud speaker and there is a d.c. drop due to the plate current through the speaker. If this drop exceeds $13\frac{1}{2}$ volts, as is very likely when using power tubes and high resistance speakers, the reversed *C* battery must be used to bring the grid bias down to $13\frac{1}{2}$ volts. If the drop is less than this value the *C* battery is connected in the usual manner but is less than usual. Where a set uses some kind of output coupler between the plate and the power tube, the tube voltmeter is placed directly across the speaker, using the regular *C* battery connections. Fig. 11 shows the connection in this case.

The usual type of a.f. oscillator is quite efficient here, but recently the beat frequency oscillator has become popular. It has the advantages of better wave form, ease of tuning to any desired frequency, and a very constant output. Such a beat frequency oscillator is shown in Fig. 12. It comprises two oscillators, one of which is fixed, the other variable. The two oscillators are very loosely coupled to a detector and one step impedance coupled amplifier, and the audio note is obtained by a frequency difference in the two oscillators. This type of oscillator may be made to go down to very low frequencies by using very loose coupling. A power amplifier will increase this to sufficient level to make any speaker roar.

When measuring the gain of the power tube, a much higher level is used than in the first stage, usually 15-20 volts across the speaker. This means that a larger milliammeter must be substituted for the 1.5 milliamperé instruments. Also if the voltmeter is placed directly across the speaker, as in Fig. 10, a milliammeter must be placed in the plate circuit of the power tube to be sure that the plate current does not change due to overloading, as this will alter the grid bias.

The measurement of the gain through the detector requires both a.f. and r.f. equipment. The circuit is shown in Fig. 13 and shows the signal being supplied to the detector grid by the r.f. potentiometer and thermocouple, as in the case of the single stage r.f. gain. The essential difference is that this must be a modulated signal and the percentage of modulation must be held at a constant value, simulating broadcast transmission. This may be accomplished by modulating the r.f. oscillator by the Heising system, holding the percentage of modulation constant by means of a tube voltmeter across the modulation choke coil.

The output is not measured on the grid of the first a.f. tube but on the grid of the second a.f. tube, the gain through the second stage having been measured

(Continued on Page 46)

FROST-RADIO

ANNOUNCEMENT

AT THE Radio Trade Show in Chicago the week of June 11 Frost-Radio will announce a new and improved line of Quality Parts. This new line will be well worth waiting for. Descriptive literature will be ready for release on or before the opening of the Show. Have us place your name on our list to receive this literature. Write us now about this, while the matter is fresh in mind.

HERBERT H. FROST, Inc.

New York City

ELKHART, IND.

Chicago, Ill.

TOBE

SIMPLIFIED "A" SUPPLY

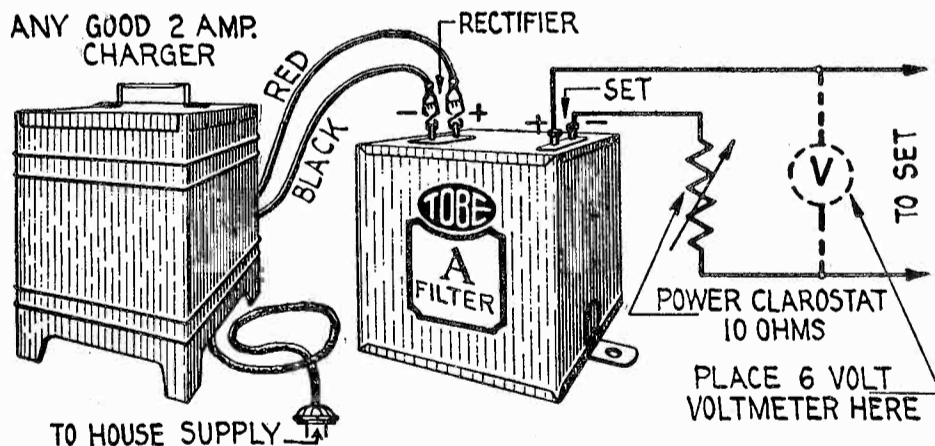

An "A" FILTER consisting of a new and different DRY condenser of 7600 Mfd. with two especially designed choke coils of proper size combined in one unit to supply HUMLESS "A" CURRENT to any radio set.

This new filter can be attached to any good two ampere charger as shown, for completely eliminating the "A" BATTERY.

Without a charger, only a rectifier and step down transformer are needed to assemble this eliminator in a few moments as the principal wiring is done inside of the TOBE "A" FILTER.

TOBE "A" CONDENSER is also sold separately.

For sale by all the better dealers.

TOBE DEUTSCHMANN COMPANY
11 WINDSOR ST.,
CAMBRIDGE, MASS.

Please send me Pamphlet P-1 on your new "A" FILTER and "A" CONDENSER.

Name

Address

Tell them you saw it in RADIO

Power--Quality

New Altone--

12⁵⁰

POWER SPEAKER

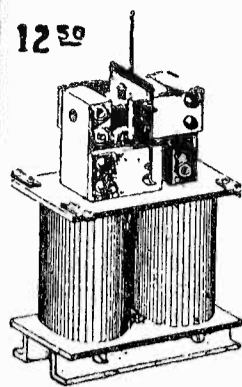

Employs famous DYNATONE ELECTROMAGNETIC Power Unit. The only speaker not affected by climatic changes. Unit price, \$12.50. Attach it to your own speaker. Enjoy the best in radio reproduction.

Buy without hesitation on our absolute money back guarantee. Your money back if not satisfied. Works on any set. Will take the output of 250 push pull without distortion or rattling. You will love the rich bass note and tonal brilliancy.

Complete kit.....	\$18.50
Dynatone electromagnetic unit.....	12.50
Piano units.....	10.00
3 ft. cone speaker kit.....	11.00
Altone Balloon cloth speaker.....	11.50

Mail Orders Filled Promptly

EXPERIMENTERS RADIO LABS

25R Church Street, New York

Prices Reduced on Jensen Dynamic Speakers

Write Now for Catalog of Radio Supplies Distributed by Us
INFRADYNES, SUPERS, S. M. KITS
Radio Constructors Corporation
 357 12th St. Oakland, Calif.

Improves A-C reception —saves tubes!

This small and inexpensive device makes tubes last longer. Eliminates practically all A-C hum. Does away with most, if not all, of the noises that come over your house current line. The

Wirt A-C Voltage Regulator adds perfection to an already satisfactory set. It permanently safeguards condensers, tubes, etc., and prolongs their life. Ask your dealer to show you the new

"A-C Voltage Regulator, No. 211". If he cannot supply you, get real A-C satisfaction by sending your dealer's name and \$2.25 direct to

Easy to install

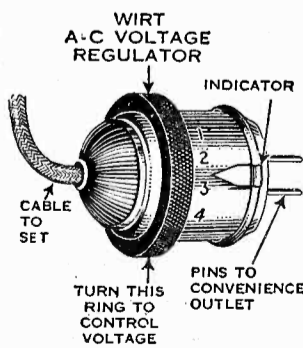

WIRT COMPANY
 5221 Greene St., Philadelphia, Pa.
 Makers of "Dim-a-lite" and "Dim-a-lamp"

(Continued from Page 45)

by the foregoing procedure originally. The output voltmeter is calibrated over a wide range of voltages and the input is set at 0.2 volts, corresponding to a setting of 5 on the main scale on the potentiometer, with the input current at the proper value for the frequency of the carrier. The output is measured on the tube voltmeter and the calibration gives the voltage here. Dividing this by the gain through the audio stage at that audio frequency gives the voltage on the input of the first audio tube. Multiplying this by 5 gives the detector gain. Repeat the process for various r.f. and a.f. frequencies, thereby analyzing the detector efficiency under all conditions. It is evident that this is the most difficult of all the measurements and as there are very few variations made in detector design it is usually omitted.

As in the case of the r.f. stages, the over-all a.f. gain is the product of each single stage gain. Thus a gain of 5 from the detector to the first a.f., a gain of 30 through the next stage and a gain of 2 through the power stage to the speaker gives a total a.f. gain of $5 \times 30 \times 2 = 300$.

If the r.f. gain is 500 the total amplification from the antenna to the speaker is $300 \times 500 = 150,000$. This means that a signal of 100 micro volts on the antenna would produce a loud speaker voltage of 15 volts. This is, of course, at the percentage of modulation for which the detector was measured. Some other percentage of modulation would, of course, produce an altogether different over-all gain.

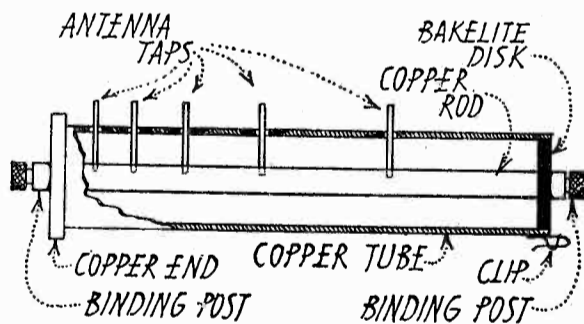

Fig. 14. Attenuator for Measurement of Over-all Gain

Overall Gain Measurement

WHILE single stage gain measurements are extremely useful in choosing the parts for a receiver, the final design is also affected by the general disposal of the parts, the amount of over-all feed back, etc. These effects can only be obtained by over-all gain measurements. This means the complete measurement of the receiver as a whole.

These over-all measurements may be either of the r.f. system alone or of the whole set. The r.f. over-all gain is instructive as it shows readily just how much pep the set has, but the quality of the set cannot be obtained in this manner. The quality is affected by the sharpness of tuning, by the distortion of the detector, and by the frequency characteristics of the audio system. So that the only final test of quality is an over-all measurement from antenna to speaker.

In both of these methods a special attenuator is used, illustrated in Fig. 14. This consists of a copper rod inside a copper tube. The rod is $\frac{1}{2}$ in. in diameter, the tube 1 in. inside diameter. At one end the rod and tube are connected together and at the other end they are separated by a bakelite disc. At points $\frac{3}{16}$ in., $\frac{3}{8}$ in., $\frac{3}{4}$ in., $1\frac{1}{2}$ in., 3 in., 6 in. and 12 in. from the common end, leads are brought out from the rod to a terminal strip by means of small rods brought out through the tube, these small rods being threaded into the rod and clearing the tube by a safe amount. The receiver ground connects to the common end of the rod and tube and the antenna is placed on the leads from the rod.

This type of attenuator possesses an inductance which is independent of frequency and which can easily be calculated by the formula: Inductance in microhenries per c.m. = $\frac{.004605 \log_{10} \frac{\text{inside diameter of tube}}{\text{diameter of rod}}}{\text{diameter of rod}}$.

The inductances of the various taps of the attenuator described above are .00075 m.h. for the $\frac{3}{16}$ in. tap, .00151 m.h. for the $\frac{3}{8}$ in., .00301 for the $\frac{3}{4}$ in., .00602 for $1\frac{1}{2}$ in., .01204 for 3 in.,

(Continued, on Page 48)

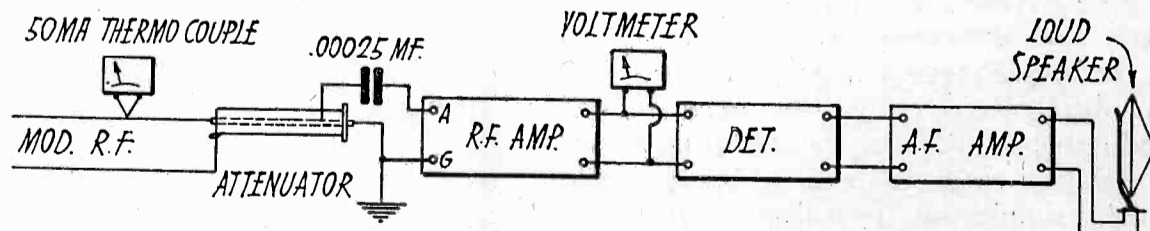

Fig. 15. Application of Attenuator to Measurement of R.F. Gain from Antenna to Detector

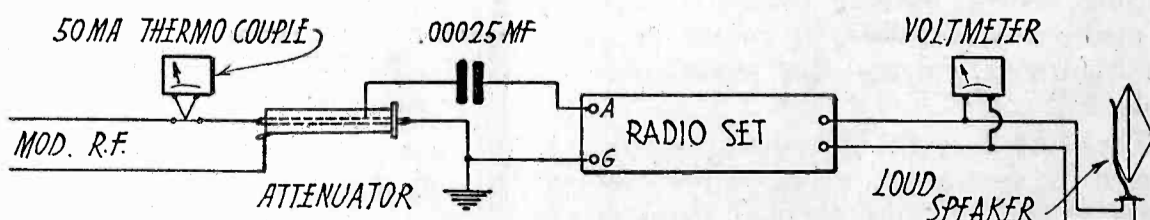
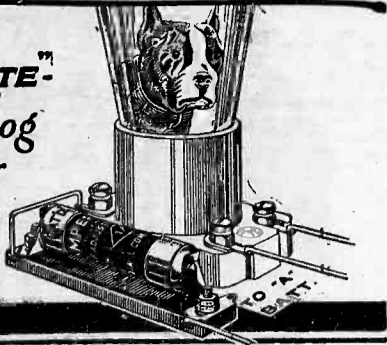

Fig. 16. Application of Attenuator to Measurement of Over-all Gain from Antenna to Loudspeaker

Tell them you saw it in RADIO

"AMPERITE"
Watch Dog
of your
Tubes



Simplifies-

1. Tube control—No knobs
2. Wiring—Short leads
3. Panel design—No drilling
4. Tuning—No hand rheostats

Only AMPERITE can automatically keep the temperature or voltage of the filament constant despite variations in "A" battery voltage. Particularly essential with eliminators. Proved for 6 years to be indispensable in every radio circuit. Do not confuse with fixed filament resistors. Accept only AMPERITE. Price \$1.10 with mounting (in U.S.A.). At all dealers.

Write for Free "Amperite Book" of season's best circuits and latest construction data. Address Dept. R6

Radiall Co., 50 Franklin St., New York

AMPERITE
REG. U.S. PAT. OFF.
The "SELF-ADJUSTING" Rheostat

ORDER YOUR BLUEPRINTS
NOW

for the new 1928 G. M. Best Super

\$1.00 Per Set, Postpaid
"RADIO," San Francisco

QST nu9 FO
JUST OUT



June
Number

U. S. and Canada
\$1.00 Each
(Foreign \$1.10)

ONE YEAR
(4 Issues)

For \$3.25
(Foreign \$3.50)

Amateur and Commercial
Stations from 83
Countries

**RADIO AMATEUR
CALL BOOK, Inc.**
508 S. Dearborn Street
CHICAGO, U. S. A.

Samson "Pam" Amplifier

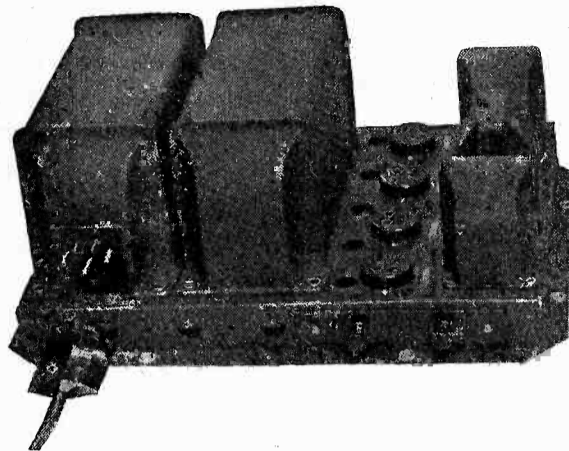

Type PAM 16 is for all ordinary types of loud speakers.

Type PAM 17 is for and supplies field current to dynamic type speakers

Type PAM 16 or 17,
List Price \$125.00 for 110 Volt, 50-60 Cycle A.C.

A COMPACT, self-contained, rugged, all electric, two stage audio amplifier for radio console or table. Designed to meet Underwriters' and A. I. E. E. standards. Compensation is made for line voltage variation. Approximate undistorted power output 7 watts.

Due to the high standard of parts used in its manufacture, the question of service ends with its installation. Immediate deliveries can be made by your jobber or dealer or direct from us.

*Immediate deliveries can be made by your jobber,
dealer, or direct from us.*

General Offices:
CANTON, MASS.

Factories:
CANTON and WATERTOWN,
MASS.

Samson Electric Co.

Manufacturers
Since 1882



Main Offices at
Canton, Mass.

ANOTHER SPECIAL OFFER!



UNI-RECTRON POWER AMPLIFIERS



Model AP-935

As the Uni-Rectron stands it is a super power amplifier, which can be used in connection with any radio set and loud speaker. Binding posts are provided for input to the Uni-Rectron and output to the speaker. Requires no batteries for its operation. It obtains its power from the 110 volt, 60 cycle alternating current lighting circuit of your house.

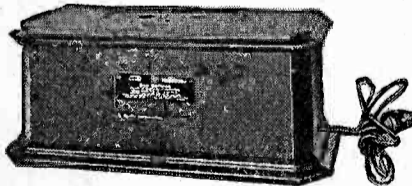

The UX-210 super power amplifying tube and the UX-216B or 281 rectifying tube are used with this amplifier, which cannot overload. From the faintest whisper to the loudest crash of sound—R. C. A. Uni-Rectron amplifies each note at its true value. High and low notes are all treated alike. The volume and quality delivered will be a revelation. Also by removing the input and output transformers it can be used as a source of power for an oscillating or transmitting tube, furnishing power for all circuits, grid, plate and filament. Every one new and packed in original factory carton

List Price \$88.50
(Without tubes)

Special at \$19.75

each

AMERICAN SALES CO., 19-21 WARREN ST., NEW YORK CITY

**PHOTOELECTRIC CELLS — GLOW LAMPS
TELEVISION APPARATUS**

WRITE FOR BULLETIN E-3

PHOTON INSTRUMENT CORP., 574 Southern Blvd., New York City

Tell them you saw it in RADIO



Always the Best!

Citizens' Radio Call Book

Spring Edition

Radio's Greatest Publication

Latest circuits, world's largest station list, helpful hints for the fan, and a wealth of radio data for the listener, set builder, jobber, dealer and experimenter.

On Sale Everywhere

50c

Published by

CITIZENS' RADIO SERVICE BUREAU

508 South Dearborn Street
CHICAGO, ILL.

(Continued from Page 46)

.02408 for 6 in., and .04817 for 12 in. When this attenuator is used with a 50 m.a. thermocouple, the input voltage to the receiver is $6.28 FLI$, when F = frequency in cycles per second, L = inductance in henries, and I = current in amperes.

The single r.f. frequency, without modulation, is used in measuring the over-all gain from antenna to detector. The Type A voltmeter is placed directly across the detector grid and the set tuned to the signal. The position of the antenna tap is adjusted together with the input current to bring the detector voltage to 1 volt, the input voltage is computed from the foregoing equation and the gain is calculated as the reciprocal of the voltage. This process is repeated at other frequencies so that a plot of the results shows the performance of the whole radio amplifier vs. frequency. A process similar to that employed for single stage selectivity will give the resonance bands of the whole set, whence sharpness of tuning can be determined.

In measuring over-all gain from antenna to speaker a modulated signal must be used. The oscillator must be equipped as for detector measurement with a tube voltmeter to hold the modulation constant. The input system uses the same attenuator and milliammeter and the input voltage is figured the same way. The tube voltmeter is placed across the speaker and the input is adjusted until the voltmeter indicates 20 volts. Whereupon the gain is $20 \div$ the input voltage. This process is repeated through the broadcast band for a number of audio frequencies. The results show both a gain of the set at various carrier frequencies and its fidelity over the audio range. These data are the most important but, of course, require more elaborate work than antenna to detector measurements. Figs. 15 and 16 illustrate these two systems of over-all measurements.



Herman Schnitzel
der Professor...
University
Cincinnati
Oh ho ho

Herman Schnitzel, famed Pacific Coast radio announcer, has published a little booklet containing 26 short radio subjects, written in his comical dialect. These stories have made a hit among thousands of broadcast listeners who have enjoyed Schnitzel's lectures. You, too, will get many a hearty laugh if you read his "works." Send for Schnitzel's book, "Unt Comes It Now." Limited supply on hand.

50 CENTS
POST
PAID

"RADIO"
Pacific Bldg.
San Francisco
California

Gerald Best's SUPER BLUE PRINTS

The complete working plans in full size for building the new incomparable Gerald Best 115 Kilocycle superheterodyne with full instructions for building.

\$1.00
1

Per set. Postpaid anywhere in the U. S. Send remittance by cash, check or money order. Stamps also accepted. "RADIO," Pacific Bldg., San Francisco, California.

for inspiring results
with the screen-grid tube

NATIONAL

Tuning-Unit Type 222 a new
NATIONAL RADIO PRODUCT
Write for Bulletin 126-P

NATIONAL CO., INC., Malden, Mass.
W. A. READY, Pres.

ANOTHER SPECIAL OFFER!

NEW GOULD

Automatic Radio "A" Power

KATHANODE Unipower

The New and Improved Gould Kathanode Unipower type AC-6k (6 volt) Automatic "A" Power Unit with built-in relay. Throws the charger on and off and controls a "B" battery Eliminator if one is to be used.

Fundamentally different from any other automatic charging "A" power device on the market.

Its Kathanode construction insures longer life

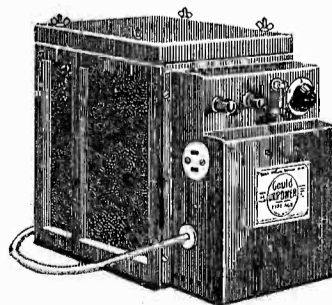

List Price, \$39.50

Extra
Special, \$15.50

and is an exclusive patented feature being used by the U. S. Government in their submarine Batteries which are furnished by Gould.

Equipped with a noiseless Bakelite Charging Unit, which has four graduated charging rates and in addition one booster rate (1½ amps.), which always keeps the battery fully charged.

Operates on 110-120 volt 60 cycle A.C.

AMERICAN SALES CO., 19-21 WARREN ST., NEW YORK CITY

Tell them you saw it in RADIO



TRAVELERS select the Great Northern for its wonderful location in Chicago's "loop". They return because the large comfortable rooms, homelike environment, attentive service, excellent food and moderate charges make it an ideal hotel.

400 Newly Furnished Rooms
\$2.50 a day and up

Sample Rooms
\$4.00, \$5.00, \$6.00
\$7.00 and \$8.00

WALTER CRAIGHEAD
Manager

Dearborn St. from Jackson to Quincy
New Garage One-Half Block

SHIP AERIAL

GENUINE SAWCA heavy duty 718 and 722 Silicon Bronze Ship Aerial, exactly as employed by ocean liners, ships, wireless and major broadcasting stations. Conductivity, pick-up energy and distance range greater than any other antenna wire available. Prices, per foot 722, two cents. 718 three cents, F.O.B. Brooklyn. Sample of either, 10 cents.

Ship Aerial Wire Co. of America
217 Wyckoff Avenue Brooklyn, N. Y.

MAJESTIC

Means Greater Radio Values
at less cost to you.

GRIGSBY-GRUNOW CO.
4540 Armitage Ave. Chicago, Ill.

Be Your Own Broadcaster

Fool
Your
Friends!



The Sky Is the Limit

A New Idea for a Radio Party!

The mystic Home Broadcaster is attached to any radio set in a jiffy. No skill required. Stretch long extension cord into another room or closet, press the switch button on the microphone which automatically cuts off radio reception and you begin to broadcast.

Then the Fun Begins!

Sing—Joke—Play—The sky is the limit! Release the button and radio reception comes through once more. Slip a Home Broadcaster in your pocket when you go to the next radio party and see what happens. It is not necessary to remove the Broadcaster from the Set. It can be left permanently connected to the Set as it will not interfere with radio reception. The Broadcaster is therefore always ready for instant use.

Send No Money!

Pay postman \$4.95 plus postage for the Home Broadcaster outfit consisting of Microphone, Special extension cord and adaptor plug. State whether you want the Type U. X., using 4-prong detector tubes or Type A. C., using 5-prong detector tubes. If you are not entirely satisfied your money will be returned.

ELBA PRODUCTS MFG. CO.

726 Atlantic Avenue, B'klyn, N. Y., Dept. 106

STATEMENT OF OWNERSHIP, MANAGEMENT, CIRCULATION, ETC., REQUIRED BY THE ACT OF CONGRESS OF AUGUST 24, 1912.

"RADIO," published monthly at San Francisco, Calif., for October 1st, 1927.

State of California, County of San Francisco, ss.

Before me, a Notary Public in and for the State and county aforesaid, personally appeared H. W. Dickow, who, having been duly sworn according to law, deposes and says that he is the Business Manager of "RADIO," and that the following is, to the best of his knowledge and belief, a true statement of the ownership, management, etc., of the aforesaid publication for the date shown in the above caption, required by the Act of August 24, 1912, embodied in section 443, Postal Laws and Regulations, printed on the reverse of this form, to-wit:

1. That the names and addresses of the publisher, editor, managing editor, and business managers are:

Publisher, Pacific Radio Publishing Co., Pacific Bldg., San Francisco; Editor, Arthur H. Halloran, Berkeley, Calif.; Managing Editor, None; Business Manager, H. W. Dickow, Pacific Bldg., San Francisco.

2. That the owner is:

Pacific Radio Publishing Co., Pacific Bldg., San Francisco; Arthur H. Halloran, Berkeley, Calif.; H. W. Dickow, Pacific Bldg., San Francisco; H. L. Halloran, Berkeley, Calif.

3. That the known bondholders, mortgagees, and other security holders owning or holding 1 per cent or more of total amount of bonds, mortgages, or other securities are: None.

4. That the two paragraphs next above, giving the names of the owners, stockholders, and security holders, if any, contain not only the list of stockholders and security holders as they appear upon the books of the company but also, in cases where the stockholder or security holder appears upon the books of the company as trustee or in any other fiduciary relation, the name of the person or corporation for whom such trustee is acting, is given; also that the said two paragraphs contain statements embracing affiant's full knowledge and belief as to the circumstances and conditions under which stockholders and security holders who do not appear upon the books of the company as trustees, hold stock and securities in a capacity other than that of a bona fide owner and this affiant has no reason to believe that any other person, association, or corporation has any interest direct or indirect in the said stock, bonds or other securities than as so stated by him.

H. W. DICKOW,
Business Manager.

Sworn to and subscribed before me this 20th day of March, 1928.
(SEAL)

JOHN L. MURPHY,

Notary Public in and for the City and County of San Francisco, State of California. My commission expires August 19th, 1931.

Tell them you saw it in RADIO

RADIO ADS

A CLASSIFIED ADVERTISING SECTION READ BY BETTER BUYERS

The rate per word is eight cents net. Remittance must accompany all advertisements. Include name and address when counting words.

Ads for the July Issue Must Reach Us by June Fifth

MEN—Big pay working romantic, wealthy South America. Fare, expenses paid. South American Service, 14,600 Alma, Detroit, Mich.

DO YOU GET TIRED of buying "B" Batteries? A lifetime Edison will solve your troubles. Good, live, large size elements connected with pure nickel wire, electrically welded, 7c pair. All parts for sale. Sample cell and dope sheet, 10c. Paul Mills, Woodburn, Oregon.

BUMBLEBEE amateur transmitter complete with motor generator ready to operate. 15 Watts. Beautiful walnut cabinet mounting with heavy iron angle bracket supports for coils. Exactly as pictured and described by Gerald Best in May, 1927 issue of "Radio." Motor generator mounted on substantial base with quadruple belt drive. Absolutely in perfect condition. Never used. Cost more than \$200.00. Will sell for \$100.00 without tubes, f.o.b. San Francisco. All copper coils and mechanical work by Heintz and Kaufmann, built to our specifications. A real buy. D. B. McGown, 435 Pacific Building, San Francisco, Calif.

RADIOBUSTER—A book of a dozen Alaskan radio stories by Volney G. Mathison. Bound in cloth. Acknowledged as the best radio fiction. Price, \$1.00 per copy. Postpaid anywhere. "RADIO," 433 Pacific Bldg., San Francisco.

BE THE LICENSED RADIO DOCTOR IN YOUR COMMUNITY. \$7 to \$10 spare time evenings. Our co-operative plan procures all the work you want. Secure franchised territory now. Write for booklet. Co-operative Radio Doctors, Dept. P., 131 Essex St., Salem, Mass.

YOUR POWER TROUBLES SOLVED. Sturges "AB" eliminators, bulb "B" dry trickle. Completely automatic. \$25.00 complete. Literature! Wilmax, 819 DeKalb Ave., Brooklyn, N. Y. C.

JUST OFF THE PRESS. Thoroughly revised; down to the minute with much new material never published; greatly improved and enlarged; no advance in price. Fourth Edition, "Radio Theory and Operating," by Mary Texanna Loomis, President, Loomis Radio College; member, Institute of Radio Engineers. Nearly 900 pages. Over 700 illustrations. Beautifully bound in flexible red craft leather, stamped in gold. Complete text and reference book on radio; special chapter on "Aircraft Radio"; much European material added, especially British. Ever since publication of first edition in 1925 this book has been used as a text by practically all the leading radio schools in the United States and Canada, also many universities, technical colleges and high schools, and all Government radio schools. Recognized as America's standard radio textbook. Contains wealth of practical and systematically arranged information. Different from other works on the subject; is understandable and interesting; not just page after page of dry theory. Fills a long-felt want in the line of radio text and reference books. Is a library in itself and you should have a copy, if interested in radio. For sale at nearly all bookstores in United States, also in Shanghai, China; London, England; Melbourne, Australia; Wellington, New Zealand; Calcutta, India; Honolulu, T. H.; Manila, P. I.; Vancouver, B. C. Price \$3.50. Buy of your book dealer, or send check or money order for prompt delivery to Loomis Publishing Company, Dept 12, Washington, D. C.

TRADE new Thordarson R76 output transformer. What have you? A. W. Rabe. Westwood, California.

ALUMINUM cut to order for panels, baseboards, shields, cabinets. WHITES, 217 Wyckoff Ave., Brooklyn, New York.

SAVE 50%. Get 2 radio magazines for the price of one. "CITIZENS' RADIO CALL BOOK" and "RADIO." Both for a full year for \$2.50, the price of "RADIO" alone. "RADIO," Pacific Building, San Francisco, Calif.

RADIO GENERATORS. All types and sizes. New and Used. Bargain prices. Half kilowatt 500 cycle Crocker-Wheeler Navy Type motor generators, \$80.00, new. With spare parts, \$100.00, including spare armature. D C machines of all sizes. Transmitting parts, transformers, condensers, and transmitters complete. "Push pull" plate and grid condensers, 50 MMF, 10,000 volt test, each \$2.50. D. B. McGown, 1247 Forty-seventh Ave., San Francisco.

I Will Train You at Home to Fill a Big-Pay Radio Job

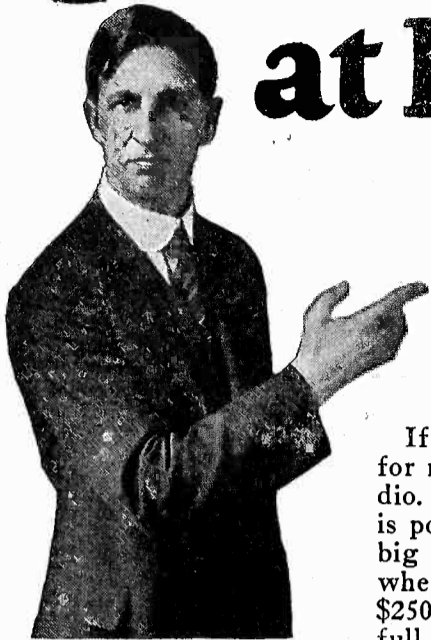

**You can build
100 circuits with
the six big outfits
of Radio parts
I give you**

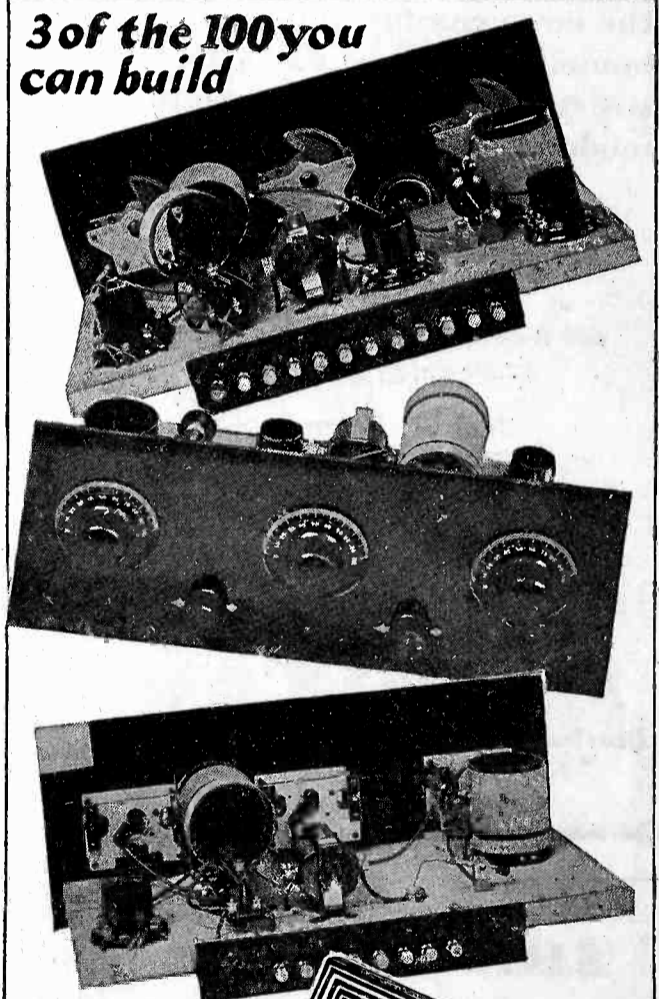

**Find out quick
about this
practical way
to big pay**

Mail This FREE COUPON Today

J. E. SMITH, President,
Dept. 6-R, National Radio Institute,
Washington, D. C.

Dear Mr. Smith: Kindly send me your big book
"Rich Rewards in Radio," giving information on
the big-money opportunities in Radio and your
practical method of teaching with six big outfits.
I understand this book is free, and that this places
me under no obligation whatever.

Name.....Age.....
Address.....
City.....State.....
Occupation.....

Here's the PROOF



**Made \$185 in
Three Weeks
Spare Time**
"I have met with
continued success.
For instance, re-
cently I realized
a profit of \$185
in three weeks,
\$1.50 an hour. I have been
making good money almost
from the time I enrolled. The
N. R. I. has put me on the
solid road to success."—Peter
J. Dunn, 901 N. Monroe St.,
Baltimore, Md.

Made \$588 in One Month
"The training I
received from
you has done me
a world of good.
Some time ago
during one of our
busy months I
made \$588. I
am servicing all
makes of Radio receiving sets.
My boss is highly pleased
with my work since I have
been able to handle our entire
output of sets here alone."—
Herbert Reese, 2215 So. E. St.,
Elwood, Indiana.



**Earns Price of Course in
One Week Spare Time**
"I have been so busy with
Radio work that I have not
had time to study. The other
week, in spare time, I earned
enough to pay for my course.
I have more work than I can
do. Recently I made enough
money in one month spare
time to pay for a \$375
beautiful console all-electric
Radio. When I enrolled I
did not know the difference
between a rheostat and a coil.
Now I am making all kinds
of money."—Earle Cummings,
18 Webster St., Haverhill,
Mass.

If you are earning a penny less than \$50 a week, send for my book of information on the opportunities in Radio. Its FREE. Clip the coupon NOW. A flood of gold is pouring into this new business, creating hundreds of big pay jobs. Why go along at \$25, \$30 or \$45 a week when the good jobs in Radio pay \$50, \$75 and up to \$250 a week. My book "Rich Rewards in Radio" gives full information on these big jobs and explains how you can quickly become a Radio Expert through my easy, practical home-study training.

Salaries of \$50 to \$250 a week not unusual

Get into this live-wire profession of quick success. Radio needs trained men. The amazing growth of the Radio business has astounded the world. In a few short years three hundred thousand jobs have been created. And the biggest growth of Radio is still to come. That's why salaries of 50 to \$250 a week are not unusual. Radio simply hasn't got nearly the number of thoroughly trained men it needs. Study Radio and after only a short time land yourself a REAL job with a REAL future.

You Can Learn Quickly and Easily in Spare Time

Hundreds of N.R.I. trained men are today making big money—holding down big jobs—in the Radio field. Men just like you—their only advantage is training. You, too, can become a Radio Expert just as they did by our new practical methods. Our tested, clear training makes it easy for you to learn. You can stay home, hold your job, and learn quickly in your spare time. Lack of education or experience is no drawback. You can read and write. That's enough.

Many Earn \$15, \$20, \$30 Weekly on the Side While Learning

My Radio course is the famous course "that pays for itself." I teach you to begin making money almost the day you enroll. My new practical method makes this possible. I give you SIX BIG OUTFITS of Radio parts with my course. You are taught to build practically every type of receiving set known. M. E. Sullivan, 412 73rd Street, Brooklyn, N. Y., writes: "I made \$720 while studying." Earle Cummings, 18 Webster Street, Haverhill, Mass., "I made \$375 in one month." G. W. Page, 1807 21st Ave., Nashville, Tenn., "I picked up \$935 in my spare time while studying."

Your Money Back if Not Satisfied

I'll give you just the training you need to get into the Radio business. My course fits you for all lines—manufacturing, selling, servicing sets, in business for yourself, operating on board ship or in a broadcasting station—and many others. I back up my training with a signed agreement to refund every penny of your money if, after completion, you are not satisfied with the course I give you.

ACT NOW—64-page Book is FREE

Send for this big book of Radio information. It won't cost you a penny. It has put hundreds of fellows on the road to bigger pay and success. Get it. Investigate. See what Radio has to offer you, and how my Employment Department helps you get into Radio after you graduate. Clip or tear out the coupon and mail it RIGHT NOW.

J. E. SMITH, President,
Dept. 6-R,
National Radio Institute
Washington, D. C.



Employment Service to all Graduates
Originators of Radio Home Study Training

Tell them you saw it in RADIO

VOLUME AND QUALITY

has always been the demand in regard to audio units. The most recent contribution is the UX 250 (CX 350) power amplifier tube. This tube is capable of delivering to the speaker three times more undistorted energy than a UX 210. To realize the full possibility of this new tube it must be used with equipment especially designed for it. General Radio have developed a complete line of transformers and filters especially for this new power tube. Folders describing complete amplifier units and component apparatus will be sent on request.

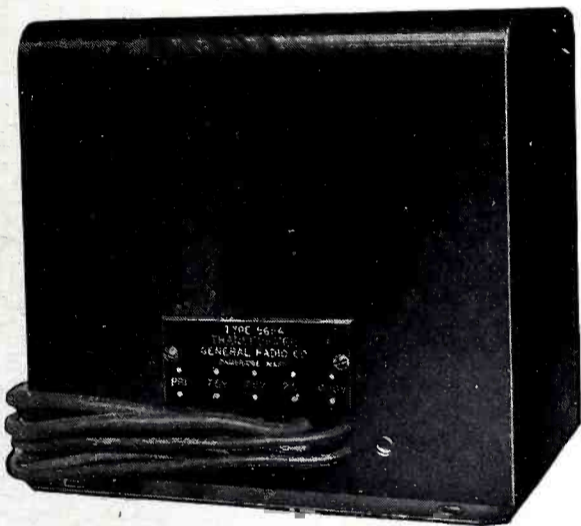

Type 565-A TRANSFORMER

A transformer designed for half wave rectification when used with one UX 281 Rectifier tube or equivalent. Rated at 200 watts, Primary designed for 105—120 volt 56-60 cycle AC line. High voltage secondary of 600 volts. Two low voltage secondaries of 7.5 volts each for filament of rectifier and power amplifier tubes together with one secondary of 2.5 volts.

PRICE\$20.00



Type 527-A RECTIFIER FILTER

A complete filter unit mounted in the same style case as the Type 565-A transformer. This instrument consists of two heavy duty chokes of approximately 13 henries each having a current rating of 100 milliamperes and a condenser combination of 4-2-4 mf. The condensers are rated at 1000 volts while the direct current resistance of each choke coil is but 175 ohms.

PRICE\$25.00

GENERAL RADIO

QUALITY APPARATUS

Bulletin No. 929 describing complete line of quality apparatus will be sent on request

GENERAL RADIO COMPANY

30 State St., Cambridge, Mass.

274 Brannan St., San Francisco, Calif.

ABOX

"A" BATTERY ELIMINATOR

A. C. OPERATION—

Without Change in Set Wiring or Tubes

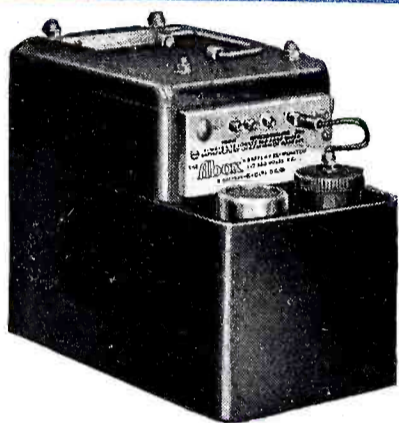

6-Volt Abox Eliminator

This model will operate any set using eight or less standard 6-volt tubes. Not necessary to change set wiring. Over 100,000 of this type in use.

\$32⁵⁰

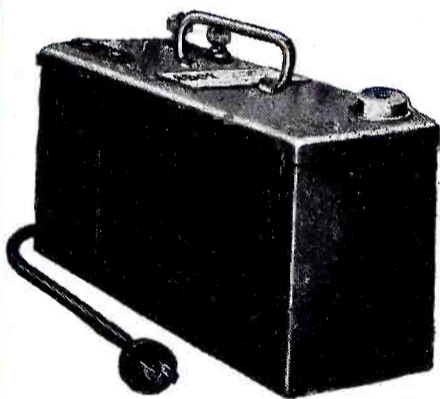

4-Volt Abox Eliminator

A new model for sets using 4-volt tubes. Fits Radiola battery compartment. Size 8³/₄ in. long, 4 in. wide, 6⁷/₈ in. high. Output—.6 amperes, 4 volts D. C.

\$27⁵⁰

All Prices Slightly Higher on West Coast

Changing to electric operation is a step toward convenience and dependability. By all means do it, but do not overlook the advantages of using the most sensitive tubes available.

A. C. operation using Abox is the most practical, economical and satisfactory method because it changes house current to the kind of power necessary to operate proven standard tubes.

Abox is a rectifier-filter combination adaptable to any receiver using eight 1/4 ampere tubes or less, or sixteen of the proposed new 1/8 ampere tubes. You make no changes in set wiring or tubes. Simply attach Abox and plug in. Reception is noticeably improved and consistently better. The convenience alone is worth the small investment.

Abox also makes available the many new special purpose tubes that improve radio operation and constitute the heart of practically all new custom-built circuits. A graphic comparison of the tubes possible to use with an Abox and the other A. C. type, is strikingly illustrated in the chart below, showing the superiority of Abox from every standpoint, where conversion is contemplated.

These tubes can be operated direct from the light socket with Abox:

UX 222 Screen Grid Amplifier	UV 199 Detector, Amplifier
UX 201B 1/8 Ampere Amplifier	UX 199 Detector, Amplifier
UX 112A Power Amplifier	UX 200A Supersensitive Detector
UX 120 Power Amplifier	UX 201A Detector, Amplifier
UX 171A Power Amplifier	UX 240 Voltage Amplifier

A. C. TYPES:

226 Amplifier

227 Detector

Use coupon for further information

The Abox Company

215 North Michigan Avenue

Chicago, Illinois

THE ABOX COMPANY

215 No. Michigan Avenue, Dept. 5, Chicago, Ill.

Please send me further information on how I can electrify my set with ABOX.

Name

Address

Check here if you are a dealer

Prais of

THE JAMES H. BARRY COMPANY
SAN FRANCISCO, U. S. A.